

January 2015



Report: EP201410210164

**Nederlandse Aardolie Maatschappij**

**Technical evaluation of Twente water injection wells ROW3,  
ROW4, ROW7, ROW9, TUB7 and TUB10  
3 years after start of injection**

This document is the property of Nederlandse Aardolie Maatschappij, and the copyright therein is vested in Nederlandse Aardolie Maatschappij. All rights reserved. Neither the whole nor any part of this document may be disclosed to others or reproduced, stored in a retrieval system, or transmitted in any form by any means (electronic, mechanical, reprographic recording or otherwise) without prior written consent of the copyright owner.

# Table of Contents

---

	Nederlandse publiekssamenvatting	3
	Technical summary	5
1	Introduction	8
2	Description of water injection system	9
2.1	Injection system	9
2.2	Injection reservoirs	10
3	Injection performance - Actual versus Plan	10
3.1	Injection rates and pressures	10
3.2	Reservoir pressures and injectivities	11
3.2.1	Reservoir pressures	11
3.2.2	Well Injectivities	12
4	Dissolution of Halite seal by sweet water injection	14
4.1	Management of Halite dissolution risk	14
4.2	Temperature logging	14
4.3	Casing calliper survey and cement bond logging	15
5	Well integrity surveillance and management	19
5.1	Annulus pressure monitoring	19
5.2	Tubing integrity	20
6	Injection water quality	21
7	Surveillance plan	26
8	Conclusions	27
9	Attachments	29
9.1	Overview of annual reported water injection data	29
9.2	Reservoir pressure development during injection	31
9.3	Step-rate test results	32
9.3.1	Well ROW3	32
9.3.2	Well ROW4	32
9.3.3	Well ROW7	32
9.3.4	Well ROW9	33
9.3.5	Well TUB10	33
9.4	Description of salt dissolution risk	34
9.5	Temperature logging results	36
9.5.1	Well ROW3	36
9.5.2	Well ROW4	36
9.5.3	Well ROW7	37
9.5.4	Well ROW9	37
9.5.5	Well TUB7	38
9.5.6	Well TUB10	38
9.6	Calliper surveys and Cement Bond Logging	39
9.6.1	Well ROW4	39
9.6.2	Well ROW9	40
9.6.3	Well TUB7	41
9.6.4	Well TUB10	42
9.7	TUB7 well surveillance results	43

## Nederlandse publiekssamenvatting

Sinds 2011 injecteert NAM productiewater, afkomstig van de oliewinning in Schoonebeek, in lege gasvelden in Twente. In dat jaar hervatte NAM de olieproductie in Schoonebeek, waar sinds medio jaren '90 geen olie meer werd geproduceerd. Voor deze activiteiten zijn diverse vergunningen verleend door verschillende overheden. Voor de waterinjectielocaties in Twente zijn specifieke vergunningen verleend door de provincie Overijssel en het ministerie van Economische Zaken. In deze vergunningen is een voorschrift opgenomen dat NAM drie jaar na aanvang van de waterinjectie een uitgebreide evaluatie diende uit te voeren naar de waterinjectie-activiteiten en de effecten daarvan op de boven het reservoir gelegen afsluitende lagen. In dit rapport worden de resultaten gepresenteerd van deze evaluatie.

Het productiewater dat vrijkomt bij de oliewinning in Schoonebeek wordt geïnjecteerd in de diepe ondergrond in een drietal leeg geproduceerde gasvelden in Twente. De oude gasreservoirs waar op dit moment water in geïnjecteerd wordt bestaan uit kalksteenlagen waarin van nature schuren zitten die er voor zorgen dat de doorlaatbaarheid van dit gesteente hoog is. De kalksteenlagen worden aan de boven en onderkant begrensd door een laag anhydriet, een gesteentesoort dat geen gas of water doorlaat en niet in water oplosbaar is. Onder en boven deze anhydrietlaag zit een dikke niet doorlaatbare laag steenzout. De combinatie van een anhydriet en steenzoutlaag vormt een zeer goede afdichting die in het verleden ervoor gezorgd heeft dat het gas gedurende miljoenen jaren in de kalksteenlagen opgeslagen kon blijven en er nu voor zorgt dat het productiewater op een veilige manier in de diepe ondergrond opgesloten blijft.

Naar aanleiding van een uitgebreide Milieu Effect Rapportage (MER) zijn vergunningen afgegeven op basis van een verwachting dat al vrij snel na de start van de olieproductie in het Schoonebeek olieveld ongeveer 12.500 m<sup>3</sup>/d productiewater geïnjecteerd zou gaan worden. In werkelijkheid is de hoeveelheid water die op dit moment per dag wordt geïnjecteerd veel minder (ongeveer 4.000 m<sup>3</sup>/d), omdat er minder olie wordt geproduceerd uit het Schoonebeek olieveld dan oorspronkelijk verwacht.

Conform het Waterinjectie Management Plan, dat onderdeel uitmaakt van de verleende vergunning, is een uitgebreid inspectie- en controleprogramma uitgevoerd voor diverse waterinjectieputten. Conform de voorschriften uit deze vergunning zijn voor de zes in gebruik genomen waterinjectieputten (genaamd ROW3, ROW4, ROW7, ROW9, TUB7 en TUB10) de resultaten geëvalueerd over de eerste 3 jaar nadat is begonnen met waterinjectie. Dit rapport bevat een gedetailleerde evaluatie van deze inspecties en testen en dient beoordeeld te worden door het bevoegd gezag. Tijdens de evaluatie is gekeken naar het injectiegedrag (injectiedruk en injectiviteit; dat is de hoeveelheid water die per eenheid van druk wordt geïnjecteerd), de huidige reservoirdruk in vergelijking met het model, de integriteit van de stalen verbuizingen in de put, de integriteit van de injectiebuis en de samenstelling van het injectiewater.

Gedurende de eerste 3 jaar zijn de injectiedrukken, als gemeten aan het oppervlak, voor alle putten nooit hoger geweest dan de in de vergunning opgenomen druklimieten (zie tabel 1 van het Waterinjectie Management Plan). Deze druklimieten zijn ingesteld met als doel de integriteit van de afsluitende lagen boven en onder de reservoirs te garanderen. Voor de putten ROW7, TUB7 en TUB10, is de reservoirdruk betrekkelijk laag gebleven gedurende waterinjectie en volgt deze het model en de verwachting. In ROW4 en ROW9 wordt een enigszins verhoogde reservoirdruk geconstateerd, maar blijft deze nog steeds ruim binnen de gestelde veiligheidsmarges van de vergunning. De metingen in ROW3 lijken aan te tonen dat het gedeelte van het reservoir waarin nu water wordt geïnjecteerd veel kleiner is dan het gedeelte waaruit voorheen gas is geproduceerd. Ook hier is de reservoirdruk ruim binnen de veiligheidsmarge gebleven die in de vergunning is vastgesteld.

De injectiviteit in de reservoirs wordt bepaald door middel van een zogenaamde 'step-rate'-test (SRT), een test waarbij op diepte van het reservoir de injectiedruk wordt gemeten terwijl de injectiesnelheid stapsgewijs wordt verhoogd. Deze testen tonen volgens de verwachtingen aan dat het water vooral wordt opgenomen in een bestaand (natuurlijk) netwerk van scheuren in deze ondergrondse formatie. De waterinjectie in ROW7, TUB7 en TUB10 wordt beschouwd als erg goed (ca. 1800-2000 m<sup>3</sup> per dag), terwijl deze in ROW4 en ROW9 (ca. 1300-1500 m<sup>3</sup> per dag) matig tot goed is. ROW3 is de enige put waar water in een zandsteenlaag wordt geïnjecteerd die op grotere diepte ligt dan de kalksteen en steenzoutlagen. In tegenstelling tot het Zechstein Carbonaat heeft dit oude gasreservoir geen natuurlijk netwerk van scheuren en heeft daarom een veel lagere injectiviteit, hierdoor wordt de waterinjectieput ROW3 slechts incidenteel gebruikt.

In de MER is uitvoerig aandacht besteed aan het mogelijk oplossen van de afdekkende steenzoutlaag indien deze laag in aanraking zou komen met het injectiewater. De MER concludeert dat deze zoutlagen niet of nauwelijks zullen oplossen in het injectiewater, echter om hierover aanvullende inzichten te verkrijgen is besloten

uitgebreide modelleringen uit te voeren. Op basis van deze uitgebreide modelleringen is aangetoond dat de conclusie uit de MER juist is. Wel is het zo dat, mocht injectiewater langs de buitenzijde van de stalen verbuizing van de waterinjectieput kunnen stromen, het theoretisch niet uitgesloten kan worden dat de zoutlaag dan plaatselijk aangetast wordt.

Ter voorkoming van zo'n situatie worden verschillende preventieve metingen in de injectieputten uitgevoerd om de status van de waterinjectieputten zeker te stellen:

1. Omdat de temperatuur van het injectiewater lager is dan de temperatuur in de diepe ondergrond zullen de zones waar water in geïnjecteerd wordt iets afkoelen. Met behulp van speciale apparatuur kan zowel in als buiten de put (dus achter de verbuizing) de temperatuur gemeten worden. Indien koude plekken worden gemeten achter de verbuizing kan dit erop wijzen dat daar injectiewater heeft gestroomd en zout heeft opgelost. In een dergelijk geval zal de waterinjectie stopgezet worden en zal nader onderzoek volgen. De waterinjectie wordt dan pas weer hervat als dit veilig plaats kan vinden, hetgeen inhoudt dat het risico op lekkage als zeer laag geklassificeerd wordt of als een reparatie uitgevoerd is.
2. De kwaliteit van de cementenwand die buitenom de gehele waterinjectieput zit, wordt gemeten met behulp van zogenaamde Cement Bond Logs (CBLs). Mocht blijken dat er kwaliteitsverschillen zijn in het cement, dan zou dit de mogelijkheid kunnen bieden voor stroming van injectiewater achter de verbuizing van een injectieput. Water wordt slechts daar geïnjecteerd waar geen aanleiding is om te vermoeden dat injectiewater achter de verbuizing in contact kan komen met zout.
3. De integriteit van de verbuizing wordt gecontroleerd door de wanddikte van de verbuizing te meten. Dit wordt gedaan door middel van een gedetailleerde diameter (of calliper) meting die afwijkingen in de wanddikte van de buis kan detecteren.

De temperatuurmetingen die in alle waterinjectieputten zijn uitgevoerd geven aan dat het water op de juiste plaats van het reservoir wordt geïnjecteerd en dat het steenzout niet aan het injectiewater is blootgesteld. Uit CBLs (zie punt 2) en calliper-metingen (zie punt 3) blijkt dat de waterinjectieput- en cementconditie goed zijn en dat het hierboven beschreven mogelijk risico van het oplossen van de zoutlaag verwaarloosbaar is.

Tijdens de genoemde inspecties en controlemetingen zijn alleen op locatie Tubbergen-7 in twee putten (genaamd TUB7 en TUB10) een aantal aandachtspunten naar voren gekomen. In de waterinjectieput TUB7 blijkt uit de wanddiktemetingen (zie punt 3) dat bepaalde onderdelen van deze put TUB7 op een diepte tussen ca. 1200 en 1500 meter een verhoogd risico op waterlekkage hadden. Nadere analyse van de inspectiegegevens van de put heeft aangetoond dat er geen sprake is geweest van feitelijke waterlekkages. De omhullende cementlaag rond de stalen injectiebuis vertoonde geen beschadigingen en vormde een extra barrière tussen injectiebuis en de aardlagen op die diepte. Wel is na deze controle besloten om de put uit voorzorg voorlopig niet meer te gebruiken voor waterinjectie zodat een reparatieplan opgesteld kan worden. In de waterinjectieput TUB10 is op een diepte van ca. 1800 meter (ter hoogte van een niet-oplosbare anhydriet laag) geconstateerd dat waarschijnlijk de schroefverbinding tussen twee buizen niet volledig vastgedraaid is. Met de CBL is geconstateerd dat de omhullende cementlaag rond de schroefverbinding van deze stalen injectiebuizen op deze plek nog intact is, waardoor er geen verhoogd risico is op lekkage door aantasting van de afsluitende zoutlaag. Daarom wordt deze put momenteel nog steeds gebruikt om op een veilige manier water te injecteren en is reparatie vooralsnog niet nodig. Mocht bij vervolgininspecties blijken dat reparatie in de toekomst nodig zal zijn, dan zal dit gerapporteerd worden aan het bevoegd gezag en zullen passende maatregelen getroffen worden om de integriteit van de waterinjectieput voldoende te waarborgen.

Betreffende de integriteit van de waterinjectieputten kan worden vastgesteld dat alle gemeten drukken binnen de in de vergunningen opgenomen druklimieten zijn gebleven. In alle waterinjectieputten zijn de wanddiktes van de injectiebuizen meer dan voldoende om de maximale verwachte injectiedruk te weerstaan. In de waterinjectieputten ROW4 en ROW9 zijn zogenaamde putstimulaties uitgevoerd, die mogelijk invloed hebben gehad op de wanddikte. Echter de huidige wanddiktes voldoen nog aan alle vereisten zodat de waterinjectie ook in deze putten veilig en verantwoord is.

Voor wat betreft de wekelijkse en maandelijkse bemonstering van het injectiewater vindt deze plaats op de Oliebehandelingsinstallatie (OBI) te Schoonebeek. Daarnaast worden er nog halfjaarlijks bemonsteringen uitgevoerd op de diverse waterinjectielocaties. Elk monster wordt uitgebreid geanalyseerd op stoffen die genoemd zijn in de vergunning. Voor elke component geldt dat de maximale verwachte concentraties en de gemeten concentraties beduidend onder de EURAL (Europese afvalstoffenlijst) limiet liggen. De genomen monsters op de OBI en waterinjectielocaties hebben nagenoeg dezelfde samenstelling. Voor een klein aantal stoffen die van nature in de ondergrond van Schoonebeek voorkomen ( $\text{SO}_4^{2-}$ ,  $\text{CO}_2$ , olie-in-water, toluen en arseen) is er soms een afwijking gemeten in vergelijking met wat van te voren verwacht was, echter de gemeten

waarden blijven ook hier ruim binnen de EURAL-limiet. De concentraties van al deze elementen zijn dusdanig laag dat het injectiewater de classificatie ‘Niet Gevaarlijke Stof’ heeft volgens de Europese Verordening EG nr.1272/2008<sup>1</sup>.

Van alle uitgevoerde inspecties hebben alleen de “step-rate”-testen niet de gewenste informatie opgeleverd. Het rapport stelt dan ook voor om meer nadruk te leggen op het meten van de reservoirdruk via drukmetingen in de waterinjectieputten terwijl er niet gepompt wordt, in plaats van het uitvoeren van deze SRT's.

Geconcludeerd mag worden dat alle in de vergunning genoemde inspectie- en testprogramma's (beschreven in het Waterinjectie Management Plan) volgens plan zijn uitgevoerd. Hierbij is aangetoond dat de in de vergunning genoemde beheersmaatregelen van het waterinjectie-programma goed werken en dat alle waarborgen voor een veilig en verantwoord opereren van de waterinjectieputten aanwezig zijn.

---

<sup>1</sup> Van toepassing zijnde wetgeving: Verordening (EG) nr. 1272/2008 van het Europees Parlement en de Raad van 16 december 2008 betreffende de indeling, etikettering en verpakking van stoffen en mengsels tot wijziging en intrekking van de Richtlijnen 67/548/EEG en 1999/45/EG en tot wijziging van Verordening (EG) nr. 1907/2006.

## Technical summary

Schoonebeek production water is injected into depleted gas reservoirs in Twente. Because of the, in the Schoonebeek FDP, assumed high plateau injection rate of 12,500 m<sup>3</sup>/d it was agreed with the authorities to share the injection data and evaluate injection performance and injection models. In reality, the actual total injection rate has only been about 4,000 m<sup>3</sup>/d, which is due to lower performance of Schoonebeek Oilfield production wells.

As specified in the Water Injection Management Plan, an extensive surveillance program was executed, followed by a 3-yearly review that was carried-out for the following injection wells: ROW3, ROW4, ROW7, ROW9, TUB7 and TUB10. Detailed evaluation of the injection performance of these wells was started in April this year after the first three-year injection period was passed. Evaluation and reporting took longer than expected causing delay in sharing this report with the authorities.

The evaluation has focused on the injection performance (pressure and injectivity), actual reservoir pressures as compared to the model, casing integrity to identify potential threats of near-wellbore salt (Halite) dissolution, well and tubing integrity, as well as on the injection water quality.

In the past three years, the actual surface injection pressures remained below the set THP-limits that were defined to avoid potential fracturing into the overlying reservoir seal. The local reservoir pressure has stayed relatively low in wells ROW7, TUB7 and TUB10 and do match the pressure prediction curve. In wells ROW3, ROW4 and ROW9 an increase in reservoir pressure is observed. ROW3 is believed to be connected to a smaller reservoir compartment in comparison to the produced gas volume. For ROW4 and ROW9 the reservoir pressure is slightly higher than predicted, but shows a decreasing trend (ROW4) or at least remained constant (ROW9). In all cases the pressures stay well below the initial reservoir pressures.

Step-rate tests clearly show, by the slope-change, that controlled formation breakdown occurred only in ROW3, the only well injecting into the non-fractured Carboniferous Sandstone reservoir. For the other wells, where water is injected into the fractured Zechstein Carbonate reservoir, the SRT-plots all show a linear trend indicating injection into existing fractures. The injection rates in wells ROW7, TUB7 and TUB10 are still considered very high (1800-2000 m<sup>3</sup>/d), whereas in wells ROW4 and ROW9 (1300-1500 m<sup>3</sup>/d) it is considered moderate, but constant. ROW3 is temporarily shut-in, because the injectivity is too low to stay below set THP limit.

Extensive modelling has indicated that significant salt dissolution could only occur under very specific conditions near an injection well. To create such a special situation, injection water needs to be able to flow directly past salt layers. This requires a combination of a leak in the production casing and a poor cement bond. Temperature logging, cement bond logging and casing calliper surveys were executed to detect injection water exposing salt. The temperature surveys indicate that injection occurs into the Zechstein reservoirs and that no injection occurred in the Halite formations. Cement bond logging and calliper surveys indicate that the risk to dissolve salt is perceived low in all logged wells. However, in TUB7 the casing calliper results show that the casing integrity is compromised at several depths. Whilst the surveillance has indicated that no leaks have occurred, the well is shut-in for injection until integrity is restored. Repair options are currently being studied. In TUB10 an anomaly in the casing is detected opposite an Anhydrite layer which may cause a potential exposure to injected water of the underlying Halite. However, the risk that the injected water will reach the Halite above and below the leak is considered low because of good cement bonding across the Halite.

Regarding well and tubing integrity it is shown that during the first 3 years of operation all A-, B- and C-annulus pressures have remained below their MAASP. All wells have enough tubing wall thickness to withstand maximum injection pressures. ROW4 and ROW9 have been acid stimulated, which may have caused increased pitting corrosion.

Weekly and monthly sampling and analysis have been carried out at the Schoonebeek Central Treatment Facilities (CTF) and at Twente injection wells on an extensive list of parameters. For all parameters the maximum expected and measured level for every respective parameter/ion is significantly lower than the EURAL (European hazardous waste catalogue) limit. In addition to EURAL, the disposal water is classified as `non-hazardous` according to the European CLP-Regulation (EC) No 1272/2008. For the vast majority of parameters the measured values are below the maximum expected values. For SO<sub>4</sub><sup>2-</sup>, CO<sub>2</sub>, oil-in-water, toluene and arsene, that are all originally present in the reservoir, occasionally higher levels were measured. Excursions of SO<sub>4</sub><sup>2-</sup>, oil-in-water and arsene are most likely linked to instabilities during the field start-up. The parameters measured in Twente, specifically at ROW2 and TUB7, give the same results than at the CTF for most parameters.

The water injection surveillance plan was executed according to plan. Evaluation of the results and the execution of the surveillance activities show that the duration of step-rate tests, carried-out to identify potential fracturing

or fracture propagation into the reservoir seal as well as to establish the injectivity, has increased from hours in 2009 to 1-2 months currently before pressure stabilization is achieved. Because of the test duration and the inability to validate the data during the long term test, it is proposed to cancel future step-rate tests and focus surveillance more on monitoring static reservoir pressure by means of static surveys and less on monitoring well injectivity by means of SRT's and fall-offs.

# 1 Introduction

In the Schoonebeek Oilfield production system, production water is re-injected since January 2011 into depleted gas fields in Twente: Tubbergen-Mander (TUM), Rossum-Weerselo (ROW) and Tubbergen (Tub). Production water is re-injected using 11 injection wells at 7 different locations.

In the Schoonebeek FDP the assumption was that during the first 3 years of operations the water injection would be at a plateau rate as high as 12,500 m<sup>3</sup>/d. Because of the exceptional high injection rates (up to 2000 m<sup>3</sup>/d for some wells) and volumes, it was agreed with the authorities to share the injection data and evaluate injection performance and injection models. The evaluation was decided to occur 6 years after start injection, because sufficient data should have been collected then. However, for a number of wells (ROW3, ROW4, ROW7, ROW9, TUB7 and TUB10) it was agreed that evaluation should take place after 3 years. Since these wells are connected to smaller reservoir volume, it was assumed that the reservoir pressure would increase sooner than in the other wells, enabling accurate model calibration. To obtain and maintain accurate modelling, relevant parameters such as the injection pressure, actual reservoir pressure and injection rate are closely monitored and measured according the Water Injection Management Plan (EP201308203212).

In reality, the actual total injection rate has only been 4,000-5,000 m<sup>3</sup>/d, which is significantly less than what was assumed in the FDP. The difference between actual and expected injection rates in the FDP is due to lower performance of Schoonebeek Oilfield production wells (Figure 1). Newer forecast (as per BP14) assumes that the water injection rate will increase to 6,000-8,000 m<sup>3</sup>/d by 2018, there can be a short peak of 9,600 m<sup>3</sup>/d around mid 2018, where after the rate gradually decreases to 6500 m<sup>3</sup>/d reached in 2026. The details of this forecast are updated on an annual basis

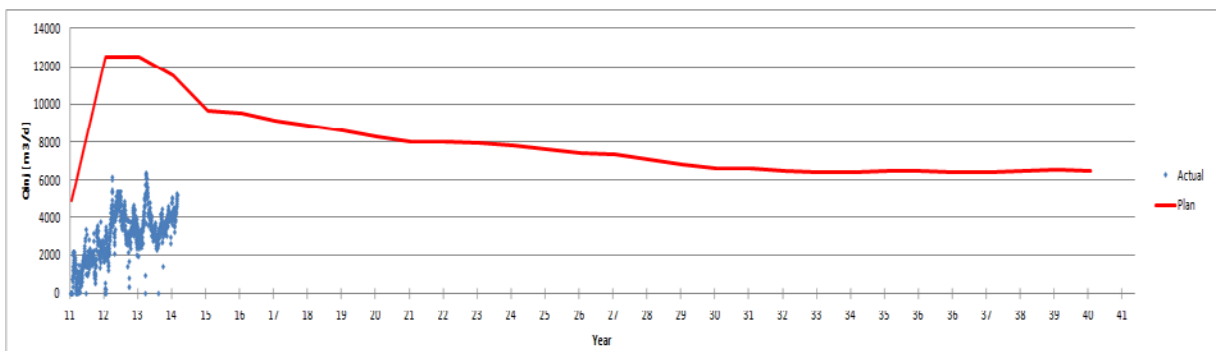

Figure 1 – Actual water injection rates compared to planned in FDP

Figure 2 shows the cumulative injection as a function of time for the 11 available water injection wells. This figure shows that water has mainly been injected into 5 wells ROW2 (performance to be evaluated 6 years after start-up), ROW7, ROW9, TUB7 and TUB10 (almost 80% of the total injected volume). For the wells that are evaluated in this report ROW3 and TUB7 have been shut in for almost a year. Well ROW3 has been long term shut in because it has a too large injection pump installed. Consequently, the injection pressure required to inject at the minimum pump rate, exceeded the THP limit. TUB7 has been closed in due to various well integrity issues. Hence, it was decided that the well will not be used for further water injection until it has been repaired.

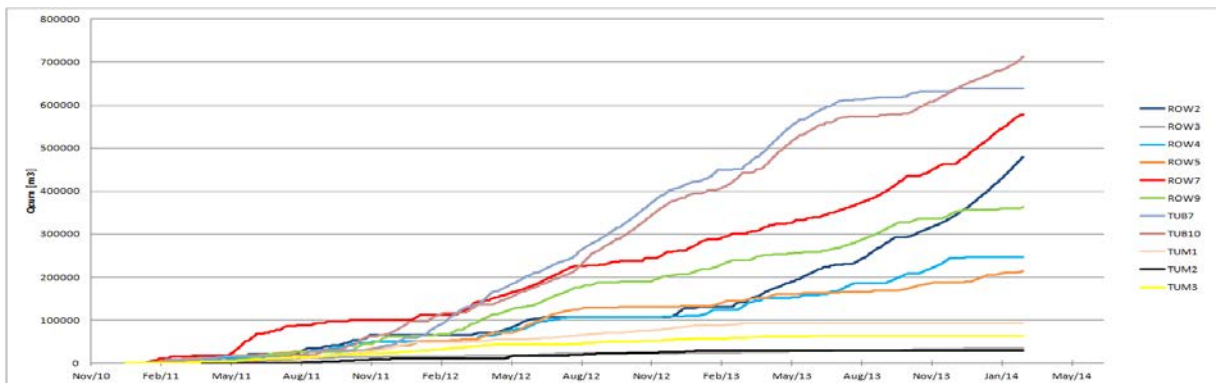

Figure 2 - Cumulative injection for all 11 available water injection wells

Annual reporting of crucial injection data, such as injection pressure (at surface as well as bottomhole), actual local reservoir pressure, injection rate, injected volume and fraction of available reservoir storage volume filled with water, has occurred for 2011, 2012 and 2013 the first quarter of the subsequent year (Attachment 9.1).



As specified in the Water Injection Management Plan, this report contains the 3-yearly review of the following wells: ROW3, ROW4, ROW7, ROW9, TUB7 and TUB10. The evaluation mainly focuses on the following:

- Injection performance (pressure and injectivity);
- Actual reservoir pressures as compared to the model;
- Casing integrity to identify potential threats of near-wellbore Halite dissolution;
- Well and tubing integrity

In addition, injection water quality over the past three years is evaluated.

## 2 Description of water injection system

### 2.1 Injection system

In the Schoonebeek Oilfield production system produced water is re-injected into depleted gas fields in Twente. These fields are the Tubbergen-Mander (TUM), Tubbergen (TUB) and Rossum-Weerselo (ROW) fields. Significant gas volumes were produced from these fields in the past providing a significant water storage capacity.

The produced water is separated from the Schoonebeek Oilfield production stream at the Central Treatment facilities (CTF). Once separated, the water is cooled to 40 °C. Subsequently, corrosion inhibitor is added after which the water exits the CTF at a flowrate of 1,900-5000 m<sup>3</sup>/d and at a pressure of 22.6-40.3 bar. The initial produced water composition is expected to be similar to that of the Schoonebeek formation water. However, with time, the ion content is expected to decrease due to dilution by the condensed 'sweet' water that originates from the steam injected into the Schoonebeek reservoir currently using 25 steam injection wells. The produced water is expected to have 50-100 ppm oil content and max 100 mg/l solids (>5 µm).

Figure 3 shows that the produced water is transported from the CTF to the Den Hulte scraper station via a new 17 km, 14" GRE pipeline. This new pipeline has a maximum capacity of 15,500 m<sup>3</sup>/d and a maximum design pressure of 40 bar. At Den Hulte the new 14" GRE pipeline will be connected to the 74 km, 18" Twente trunk line. This trunk line transports the water to depleted gas fields in Twente.

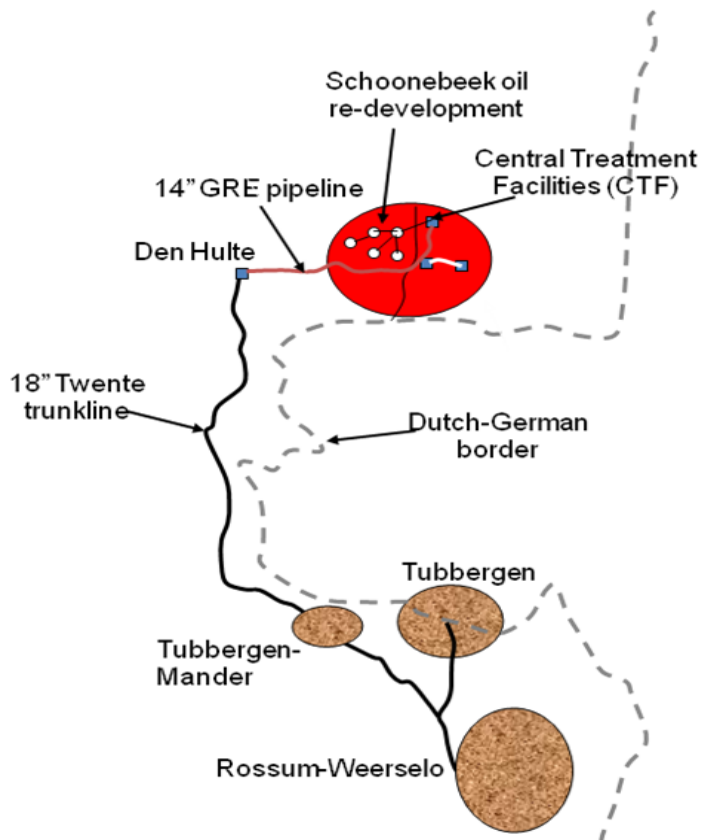

Figure 3 - Schematic representation of water injection system within Schoonebeek Oilfield production system

The transported water arrives at the Twente well sites at a pressure of approximately 5 bar and a maximum temperature of 30 °C. At every injection well a skid with a horizontal multistage ESP is installed. This ESP contains a variable speed drive, which allows the pump to be operated at the required rates and pressures.

## 2.2 Injection reservoirs

Water is injected into 2 types of reservoirs: the naturally fractured Zechstein Carbonate formation and the Carboniferous sandstone formation. The Zechstein Carbonate formation is sealed off by Zechstein salt (Halite) layers (in case of the TUB and ROW fields) or the Claystone layer in the Buntersandstone formation (in case of the TUM field). A relatively thin (5-10 mTV) Anhydrite layer separates the salt and carbonate layers. The Carboniferous sandstone formation is sealed off by salt layers.

All wells, except ROW3, are connected to two Zechstein Carbonate reservoirs, namely the Z2C and Z3C. ROW3 is connected to the Limburg (DC) sandstone reservoir.

## 3 Injection performance - Actual versus Plan

In this chapter the actual water injection, which was performed in Twente over the first 3 years of operation (2011-2013), is being discussed and compared to the plan as it was presented in the water injection FDP (EP200709211238).

In all cases, because of the low reservoir pressure and, therefore, low fracturing pressure (i.e. minimum in-situ horizontal stress) of the reservoir, water injection is mentioned to be executed under fracturing conditions. However, in most of the wells, apart from well ROW3, the water is injected into depleted Zechstein carbonate reservoirs containing an extensive fractured network already. In such cases, the existing fractures are filled with the injected water without creating new fractures. Still, during injection it needs to be prevented that fractures do propagate into the reservoir seal. For that reason, maximum tubing head injection pressures were calculated based on the fracture pressure gradient of the reservoir seal (Table 1):

$$THP_{max} = F.G_{.seal} \times TVD_{bottom\ seal} - P_{hyd}$$

In which:

- $THP_{max}$  = the surface injection pressure limit (bar)
- $F.G_{.seal}$  = the fracture gradient of the disposal reservoir seal (bar/m)
- $TVD_{bottom\ seal}$  = the true vertical depth at the bottom of the reservoir seal, i.e. at top disposal reservoir
- $P_{hyd}$  = hydrostatic pressure (assuming water density of 1.05 sg)

To apply conservative  $THP_{max}$ , note that the frictional pressure drop in the tubing is ignored. This friction can be as much as 30 bar (at 2000 m<sup>3</sup>/d flowing through a 1200 m long injection tubing).

Chapter 3.1 discusses the actual injection rates and required injection pressures. Chapter 3.2 discusses the static reservoir pressures and injectivity determined from static pressure gradients (SPGs) and step rate tests (SRTs) and fall-off tests (FOs).

### 3.1 Injection rates and pressures

Table 1 presents the maximum injection pressure for wells ROW3, ROW4, ROW7, ROW9, TUB7 and TUB10 observed at surface during the first three years. It is clear that the injection pressure remains well below the set THP-limits for these wells. For wells ROW3, ROW4 and ROW9 the maximum THP has been closer to the set THP-limits. This is due to a combination of a high local reservoir pressure and moderate injectivity. In well ROW9 the THP is sporadically high when the injection rate is high but rapidly drops again when injection rates are reduced. For wells ROW3 and ROW4 the THP is high most of the times reflecting the relatively poor injectivity in these wells.

**Table 1 - THP limits**

Well	Reservoir Depth (mTV)	Operational Pressure limit (bar)	Max. pressure observed (bar)	Max. pressure observed (% of pressure limit)
ROW-3	1692	180	174	96
ROW-4	1232	131	116	88
ROW-7	1125	119	19	16
ROW-9	1310	139	70	50
TUB-7	1312	139	17	12
TUB-10	1412	150	21	14

At times the THP was observed to increase during shut-in periods. This is due to gas migrating from the gas reservoir into the well, building up a gas pressure at surface, when the hydrostatic in the well is lower than the static reservoir pressure.

The injection pumps have been equipped with alarms and trip settings to avoid that the THP limit is exceeded. In the unlikely case the alarms are not working properly or are not picked up in time, the second fail safe mechanism in the form of the Pressure Safety Valve will automatically be activated. Besides this 2 barrier safety system, an extra safety margin of 10 % is adhered to, implying that the maximum THP applied for the operational limit is 10% lower than the maximum THP calculated from the formation integrity tests.

### 3.2 Reservoir pressures and injectivity

In all 6 evaluated water injection wells SPTG-surveys, step rate tests and fall-off tests have been carried out. From these tests the local reservoir pressure and injectivity have been determined on a yearly basis. The local reservoir pressure is reported in Table 2. In this table the depth reference for the reservoir pressure is the top of the perforations and the shut-in time for each reservoir pressure measurement is given between brackets (in days). Well injectivity determined from step-rate tests is reported in Table 4. In both tables, also the local reservoir pressure and injectivity, measured in 2009 before start water injection, have been reported. Below the static reservoir pressures and well injectivities are discussed separately.

**Table 2 - Reservoir pressure (in bars) development per well**

Well	Pinitial	2009	2011	2012	2013
ROW3	199	71	106 (28)	119 (22)	139 (5)
ROW4	150	8	46 (3)	38 (142)	36 (13)
ROW7	150	6	11 (6)	11 (43)	11 (16)
ROW9	150	11	37 (7)	34 (14)	38 (2)
TUB7	211	6	6 (2)	7 (7)	7 (99)
TUB10	211	6	7 (2)	9 (19)	13 (16)

#### 3.2.1 Reservoir pressures

The expected development of local reservoir pressure as a function of injected water volume has been modelled for each well. Herewith the water storage capacity was determined by dividing the total amount of gas produced by that particular well with the original gas formation volume factor. The storage capacity for the evaluated wells varies between 1.8 mln m<sup>3</sup> (ROW9) and 5.4 mln m<sup>3</sup> (TUB10). The resulting reservoir pressure prediction as a function of injected volume is given per well in Attachment 9.2. The actual local reservoir pressures, as reported in Table 2, have also been included in these graphs. The attachment shows that the local reservoir pressure (ref: top perforations) has stayed relatively low in wells ROW7, TUB7 and TUB10 and do match the pressure prediction curve. However, in wells ROW3, ROW4 and ROW9 an increase in reservoir pressure is observed.

For ROW3 it is believed that the well is connected to a smaller reservoir compartment in comparison to the produced gas volume. The Carboniferous (DC) map of the Rossum-Weerselo field shows that only a small corridor exists from this small reservoir compartment to the remainder of the ROW DC field. During the gas production phase this corridor was apparently big enough for significant amounts of gas to flow through. However, during the water injection phase this corridor forms a significant blockage to water flow.

For ROW4 and ROW9 the reservoir pressure increase is compared to the last SPTG survey in 2009 and observed with the first measurement after injection started in 2011, but apparently has decreased (ROW4) or at least remained constant (ROW9) after the first years of injection.

Fall-off surveys have been conducted which show that ROW4 and ROW9 have a low fracture density (i.e. large fracture spacing) as can be seen in Table 3. Due to this low fracture density water cannot travel as far through the formation as gas could during the production phase resulting in a rapid pressure build-up near the injection wells. The low fracture density, found in ROW4 and ROW9, is also apparent from the low productivity these wells showed during the gas production phase (Q<sub>50</sub> in ROW4 was only 125,000 Nm<sup>3</sup>/d and in ROW9 only 150,000 Nm<sup>3</sup>/d).

**Table 3 - Fall-off test results**

Well	Fracture spacing, m	Permeability, mD	Skin	Quality of fall-off test data
ROW4	1	4		poor
ROW7	0.2	900	3.7	poor
ROW9	5	17	-2.5	good

### 3.2.2 Well Injectivity

In each water injection well a step rate test (SRT) has been performed yearly from which the well injectivity is determined. Before executing this test a memory gauge is installed in the tailpipe nipple of the completion close to the injection reservoir. Subsequently, injection is started and the injection rate ( $Q$ ) is increased in steps. During each step the injection pressure is expected to stabilise. Plotting stabilised bottomhole pressure (BHP) versus injection rate then gives information on the injectivity. In non-fractured reservoirs, such as the Carboniferous sandstone reservoir (for ROW3), it will be evident from the change in the slope of the step-rate curve that formation breakdown has occurred and that a fracture is propagating in case injection is continued (Figure 4). However, in fractured carbonates, such as the ZeZ2C and ZeZ3C Carbonate formations, a fracture network exists and fractures are just filled with the injection water. For that reason, a change in the slope of the step-rate curve is not observed.

The SRT-data is presented for each well in Attachment 9.3. From the resulting plots, showing the BHP vs.  $Q$ , it is obvious from the slope change that formation breakdown occurred only in ROW3 (Attachment 9.3.1). Consequently, the injectivity (expressed in  $m^3/d/bar$ ) increases. For the other wells, where water is injected into the fractured Zechstein Carbonate reservoir, the SRT-plots all show a linear trend. As expected, in most wells only a very low BHP is required to inject the planned water volumes. This is because the local reservoir pressure is very low and because injectivity is in general very good. Note that the curve intersects the y-axis at approximately the reservoir pressure.

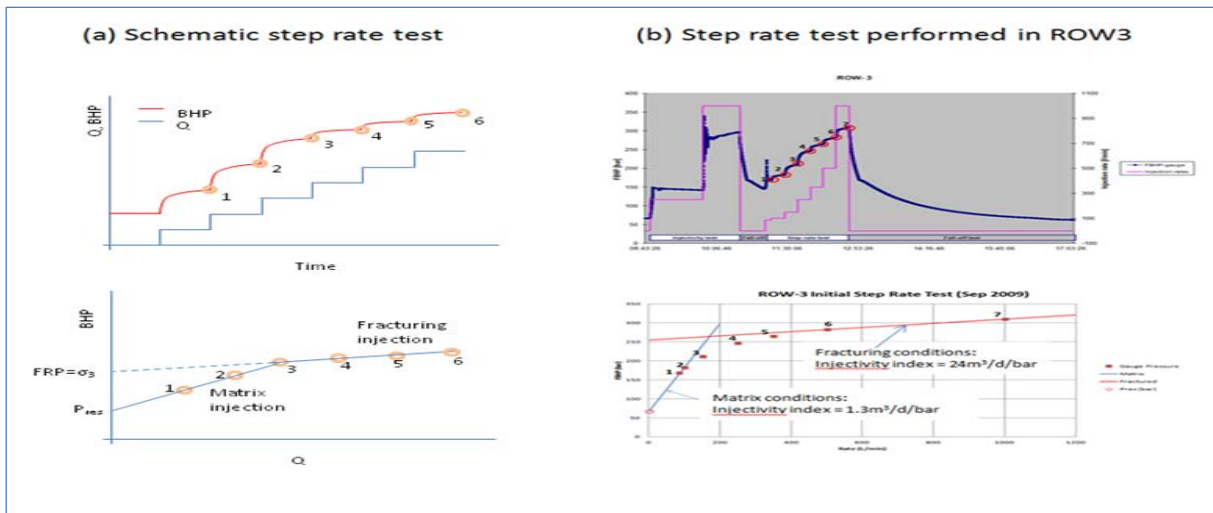

Figure 4 – Step-rate test principle applied in well ROW3

Table 4 lists the injectivities derived from the SRT carried-out in the past three years. It records if the pressures had properly stabilised during the various steps and the duration per step. The time required to achieve stable BHP was determined from the injection pressure reading at surface (THP). For that reason, it could only be verified that BHP had really stabilized from the gauge read-out once they were retrieved. In case pressure stability is indicated as poor or very poor, the outcome of the SRT must be used with care.

Table 4 shows very good initial injectivity for wells ROW4, ROW7, TUB7 and TUB10. In those wells the injectivity could not be measured even as the fluid level did not reach the BH gauge that is installed in the tailpipe nipple right above the injection reservoir. The injectivity in wells ROW7, TUB7 (currently, shut-in for integrity reasons) and TUB10 is still considered very high, whereas in wells ROW4 and ROW9 it appears to be moderate, but constant. The injectivity in ROW3 is very poor. To operate within the operational envelope of the injection pump, injection cannot be sustained as maximum THP is reached within a day at the minimum pump rate.

The low injectivity in ROW3 is due to the fact that the Carboniferous sandstone reservoir for this well does not contain a natural fracture network. In order to determine a safe operating envelope, the formation integrity and injectivity test in 2009. The test (ref SRT-plot in Attachment 9.3.1) shows that formation breakdown occurred at a low pump rate of 150-200 l/min and that but even under frac conditions the injectivity did not increase much. For comparison, in conventional hydraulic fracturing of gas wells, the injection rate applied for formation breakdown and fracture propagation is typically 10-15 times higher (2500-3500 l/min). It is expected that during the injectivity test small fractures were created in the formation but that these did not propagate away from the ROW3 well bore.

**Table 4 – Injectivities per well during the past three years**

Year	Well Parameter	ROW3	ROW4	ROW7	ROW9	TUB7	TUB10
2009	Injectivity, m3/d/bar	7	-	-	-	-	-
	Pressure stability	Very good	-	-	-	-	-
	Duration per step	15 min	15 min	15 min	-	15 min	15 min
	Remark	Injecting into fracture	Very good injectivity, no fluid at BHP gauge	Very good injectivity, no fluid at BHP gauge	No data	Very good injectivity, no fluid at BHP gauge	Very good injectivity, no fluid at BHP gauge
2011	Injectivity, m3/d/bar	-	6	-	12	-	77
	Pressure stability	-	Very poor	-	Good	-	Fair
	Duration per step	-	1 day	-	1 day	-	1-2 days
	Remark	No sustained injection		Unable to remove tree cap		Very good injectivity, no fluid at BHP gauge	
2012	Injectivity, m3/d/bar	-	6	55	9	-	130
	Pressure stability	-	Very poor	Good	Good	-	Very good
	Duration per step	-	5 days	5 days	5 days	-	5-7 days
	Remark	No sustained injection	Acid stimulated in May			No data due to faulty gauge	
2013	Injectivity, m3/d/bar	-	6	192	12	-	105
	Pressure stability	-	Very poor	Very good	Good	-	Very good
	Duration per step	-	5-7 days	14 days	7-10 days	2.5-5 h	10-12 days
	Remark	Well is shut-in long term	Acid stimulated in June	Acid stimulated in June	Acid stimulated in June	Very good injectivity, no fluid at BHP gauge	

As a standard field practice, acid stimulations have been carried out to improve injectivity in ROW4 (in May 2012 and June 2013), ROW7 (in June 2013) and ROW9 (in June 2013). The acid stimulation in ROW4 did not improve injectivity (Attachment 9.3.2), whereas a significant improvement was observed in ROW7 (Attachment 9.3.3). In ROW9 (Attachment 9.3.4) the 2013 acid stimulation restored the well back to the original 2011 injectivity levels.

An essential observation from Table 4 is that every subsequent year the required stabilisation time for the SRT's becomes longer. Before the start of water injection the injection pressures stabilised within hours whereas after 3 years of operation, the injection rate steps need to last for weeks to achieve pressure stabilisation. This is believed due to the increasing volume, and hence radius, of water build-up around the well and associated gas/water mobility. In practice, because of required available injection capacity, scheduling SRT's becomes increasingly difficult with a risk of poorer data quality. Therefore, it is intended to focus surveillance more on monitoring static reservoir pressure by means of static surveys and less on monitoring well injectivity by means of SRTs and fall-offs. The resulting surveillance plan is discussed in Chapter 7.

## 4 Dissolution of Halite seal by sweet water injection

The injection water is under-saturated with salt, whereas the salinity will decrease as time progresses due to condensed steam breaking through from the steam injection wells to the production wells. This means that the injection water has a significant capacity to dissolve salt. This salt dissolution capacity poses a potential risk in the injection wells where the injection reservoir is surrounded by salt (i.e. Halite) formations as is the case for the TUB and ROW fields.

To assess the Halite dissolution risk, modeling was performed by Shell P&T in Rijswijk. The outcome of that study, basically describing the dissolution mechanism, can be found in Attachment 9.4. The following Chapters present the surveillance that was carried-out to manage the dissolution risk.

### 4.1 Management of Halite dissolution risk

Attachment 9.4 indicates that significant Halite dissolution could only occur near the injection well under very specific circumstances where the production casing and its cement bond have degraded such that injection water can directly flow past Halite formation. Figure 5, which gives a typical water injector well schematic, shows that the production packer is in many cases set above halite layers, present in the Zechstein formation. In case the production casing and cement, located at these Halite sections, are compromised then water could freely flow past these Halite sections. A monitoring scheme, consisting of temperature logging, casing calliper surveys and cement bond logging (CBLs), was therefore applied to verify the status of the production casing and cement at the level of these Halite sections. The monitoring results for each survey are discussed in the next sections.

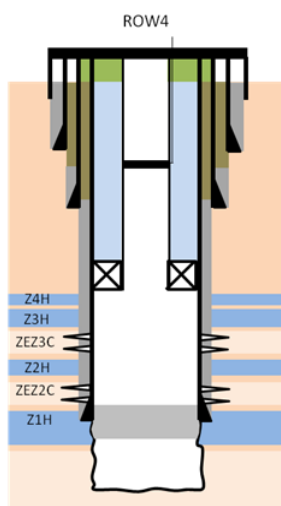

Figure 5 - Typical water injector well schematic showing Halite sections behind production casing (ZnH represents salt layers, ZeZnC represents carbonate layers where the water is injected into. Between the salt and carbonate layers is a thin anhydrite layer)

### 4.2 Temperature logging

Temperature logging has been performed to check whether injection occurs into the injection reservoirs only or also into Halite sections. For this a temperature log was run several days after injection had been stopped. Herewith the layers that received most injection are expected to warm back much slower than layers where no injection occurred. This is based on the fact that the injection water is much cooler than the injection reservoirs and surrounding reservoir seals.

The temperature survey results have been summarised in Table 5. Note that for most wells the temperature surveys indicate that injection occurs into the injection reservoirs. In wells ROW4 and ROW7 even the injection points within the Zechstein Carbonate layers can be differentiated. These injection points appear to line up very well with PLTs which have been run during the gas production phase.

The temperature surveys are shown in Attachment 9.5. Unfortunately, in TUB7 the gauges didn't record during the temperature survey. The temperature log shown in Attachment 9.5.5 is recorded at a different moment (the location of the suspected casing joint is indicated by the solid red line). Still, this temperature log also confirms that injection takes place in the ZeZ3C (delayed heat-up relative to the over-/under-burden). The survey did not cover the ZeZ2C.

Furthermore, unambiguous verification of injection into the Carbonate formations only is masked by the different conditions (i.e. volume injected and shut-in period prior logging) at which the temperature surveys are executed. ROW9 (Attachment 9.5.4) was only shut-in for 6 hours, which is relatively short to measure a clear warm back from the ZeZ3H overburden. From the temperature surveys in ROW7 (Attachment 9.5.3) and TUB10 (Attachment 9.5.6) it is relatively difficult to differentiate injection into Carbonate layers versus that into

**Table 5 - Temperature survey results**

Well	Date of survey	Injection volume (injection period)	Shut-in period	Injection into injection reservoir	Clear injection points identified within ZeZC	Comments
	dd-mon-yy	m3	days	yes/no /unclear	yes/no /unclear	
ROW3	11-Dec-12	600 (1 d)	1	yes	yes	Injection point aligns with perforations into highest porosity streak
ROW4	12-Dec-12	1,200 (20 d)	0.9	yes	yes	Injection point aligns with gas production PLT run in June 1991
ROW7	22-Jan-13	28,000 (31 d)	1.1	yes/unclear (see comment)	unclear	Injection into ZeZ2C and ZeZ3C can be differentiated vs over-/underburden. However, differentiation between ZeZ2C and ZeZ3C vs interlying Z2H is difficult due to large injection volume preceding T survey. This also complicates indentifying individual injection points within ZeZC reservoirs.
ROW9	11-Jan-13	11,000 (17 d)	0.3	yes	unclear	
TUB7	28-Feb-13					Gauges did not record during T survey
TUB10	05-Mar-13	45,000 (32 d)	1	yes/unclear (see comment)	yes/unclear (see comment)	Injection into ZeZ2C and ZeZ3C can be differentiated vs over-/underburden. However, differentiation between ZeZ2C and ZeZ3C vs interlying Z2H is difficult due to large injection volume preceding T survey. Sharp T drop observed when entering ZeZ3C. This injection point aligns with gas production PLT of Feb 1999.

the Z2H, which is located in between the Z2C and Z3C injection reservoirs. Temperature logs can always show some “smearing” effect. Because of the injection of significant volumes of cold water preceding the temperature survey it is very likely that the ZeZ2H in between the 2 injection reservoirs as well as the ZeZ3H directly overlying the ZeZ3C reservoir have cooled down as well, which causes the warm back during the shut-in period to occur much slower. Zooming in on these temperature surveys, shown for TUB10, however, does show that the warm back of the Z2H has started. For future temperature surveys it is recommended to prolong the shut-in period prior to a temperature survey to allow the Z2H to sufficiently warm back.

### 4.3 Casing calliper survey and cement bond logging

Since, as clearly shown by the temperature logs, the bulk of the water is injected into the perforated Carbonate formations or Carboniferous formation (for well ROW3), it is unclear if a relatively small leak-off via a hole in the casing is sufficient to cause a detectable cooling effect that can be picked up by temperature logging (the counter argument would be that if you cannot detect a temperature anomaly, the associated volumes cannot be significant).

Therefore, as an extra precaution, also cement bond logs (CBLs) and production casing callipers<sup>2</sup> were run to monitor whether there are any potential irregularities which could point to spots where injection water might have come in contact with the Halite formations. The results of these logs are shown in Attachment 9.6 and have been summarized in Table 6. There are several irregularities detected in TUB 7, based on which the risk level in this well is assessed at medium. In TUB 10 one suspected point is detected based on which this well is assessed at a low to medium risk. In the other logged wells the risk level is perceived very low.

ROW3 and ROW7 were not logged for the following reasons:

ROW3 is currently shut in due to a very poor injectivity implying that during injection the maximum allowable tubing head pressure is rapidly reached. This well is under investigation for potential interventions to restore/improve injectivity. In addition to the low cumulative injection volumes in this well, the injection packer is set deep, at the level of the Z1H. This formation is separated from the injection water by both a 9<sup>5</sup>/<sub>8</sub>” injection casing and a cemented 7” intermediate liner. The latter was installed in the past to shut-off gas production from the ZEZ3C. Due to this double barrier, the risk of exposing the Z1H to injection water is perceived to be very low. Based on this it was decided not to execute CBL and casing calliper.

ROW7 contains a 9<sup>5</sup>/<sub>8</sub>” production casing and 3<sup>1</sup>/<sub>2</sub>” tubing (2<sup>3</sup>/<sub>4</sub>” nipple), which makes it impossible to run a CBL. During the drilling of the well a CBL was run immediately after cementing the production casing. This CBL shows that the cement bond behind the production casing is of excellent quality.

<sup>2</sup> Casing calliper surveys were explicitly executed to identify potential discontinuities in the casing where salt layers might be directly exposed to the injected water. The objective is, therefore, fundamentally different from the tubing calliper surveys (ref. Chapter 5.2) that were carried-out to verify the injection tubing integrity status. Weak spots in the tubing, most often due to corrosion and/or erosion causing reduction of the wall thickness, can lead to tubing-annulus communication and, hence, loss of the primary well barrier. It is important to note that calliper tools are multi-finger imaging tools measuring inside, and not behind, the tubing/casing.

In February 2014 an EMIT calliper was executed across the 9 5/8" production casing. The results showed that:

- The top part (1230-1398 mAH) is in good condition
- Deeper in the well (1398-1600 mAH) more corrosion is visible, but mostly still below 10% material loss. The tool picks up distinct different corrosion profiles per individual joint, indicating a different history/manufacturing (rather than tool issues). For corrosion calculation the same theoretical assumptions are made: this introduces a relative error, but measurements done now will serve as a baseline for subsequent monitoring.

**Table 6 - Overview of CBLs and callipers run in production casing underneath injection packer**

Well	High level conclusions	c/c*	Way forward	Risk level
ROW-3	No data available on bond or corrosion, but double cased on relevant intervals.		No logging planned for this well as risk is believed very low due to double casing of relevant interval. Also investigations are ongoing whether ROW3 injection will be stopped indefinitely due to very limited reservoir storage capacity.	Low
ROW-4	Mainly good cement bond, with minor corrosion. Data quality low.		Run EMIT-PMIT next year, if good every five years.	Low
ROW-7	Legacy CBL data indicates good cement bond over relevant intervals.		Run EMIT-PMIT every five years.	Low
ROW-9	Good cement bond, no casing corrosion but minor corrosion in tubing.		Run EMIT-PMIT every five years.	Low
TUB-7	Casing is compromised at multiple locations. Good to fair cement bond over 3H and 2H, poor cement over 3C. Tubing is interspersed with individual more corroded joints. There is no evidence that actual injection water leakage has occurred		Well is shut-in for injection. Workover repair job needs to be prepared to restore casing integrity to a desired level.	Medium
TUB-10e	Good cement bond and minor to no corrosion over 3H, 3C, 2H and 2C and 1H. Potential undertorqued casing joint and no bond over 1T. There is no evidence that actual injection water leakage has occurred		Run active leak detection. Run EMIT-PMIT every three years.	Medium/Low

\*Casing / cement over halite intervals: colour coding low-medium-high. No colour = no recent data

The relevance of the monitoring program is demonstrated by well TUB7. Figure 6 shows the PMIT-A calliper readings (purple curve) registered with the PMIT tool that was run in Q4 2013. The results indicate that the casing integrity is compromised at multiple depths. In terms of salt dissolution due to injected water, most critical is a potentially undertorqued casing joint at 1463 mAHdf directly opposite the ZeZ2H salt layer. Further investigation and analysis to establish whether injected water might have leaked away at this depth and dissolved salt, has led to the following:

- Cement evaluation renders unlikely a scenario where there is a leak path from the potentially undertorqued casing joint to either ZeZ2C or ZeZ3C carbonates. There is good cement bond in between and, in addition, the CBL (measured in 2013, Attachment 9.6.3) shows a good cement to formation bond. These conditions prevent flow past the salt layer to enable salt dissolution.
- Temperature surveys, executed at various time intervals after injection stopped, show significantly faster warm back at the potentially undertorqued casing joint compared to ZeZ3C perforations (Attachment 9.5.5), suggesting there is no "cold" injection water behind pipe.
- PLT shows at high injection rates (more than 2000 m<sup>3</sup>/d) a small difference in flow rate before and after the suspected point. The measured difference is within the tool accuracy. In addition there is a small difference in internal diameter above and below this depth. Both aspects render the possible evidence for leakage as inconclusive.

Whilst deemed unlikely that a potential exposing of the ZeZ2H to injection water has occurred, the existence of multiple integrity risks in one well has led NAM to shut the injector in. Because of the high TUB7 injection capacity of 2000 m<sup>3</sup>/d and the remaining storage volume of 4.2 million m<sup>3</sup>, the plan is to restore this well as injector. An investigation into the best possible repair options is ongoing. A detailed discussion of the extensive surveillance performed in TUB 7 can be found in Attachment 9.7.



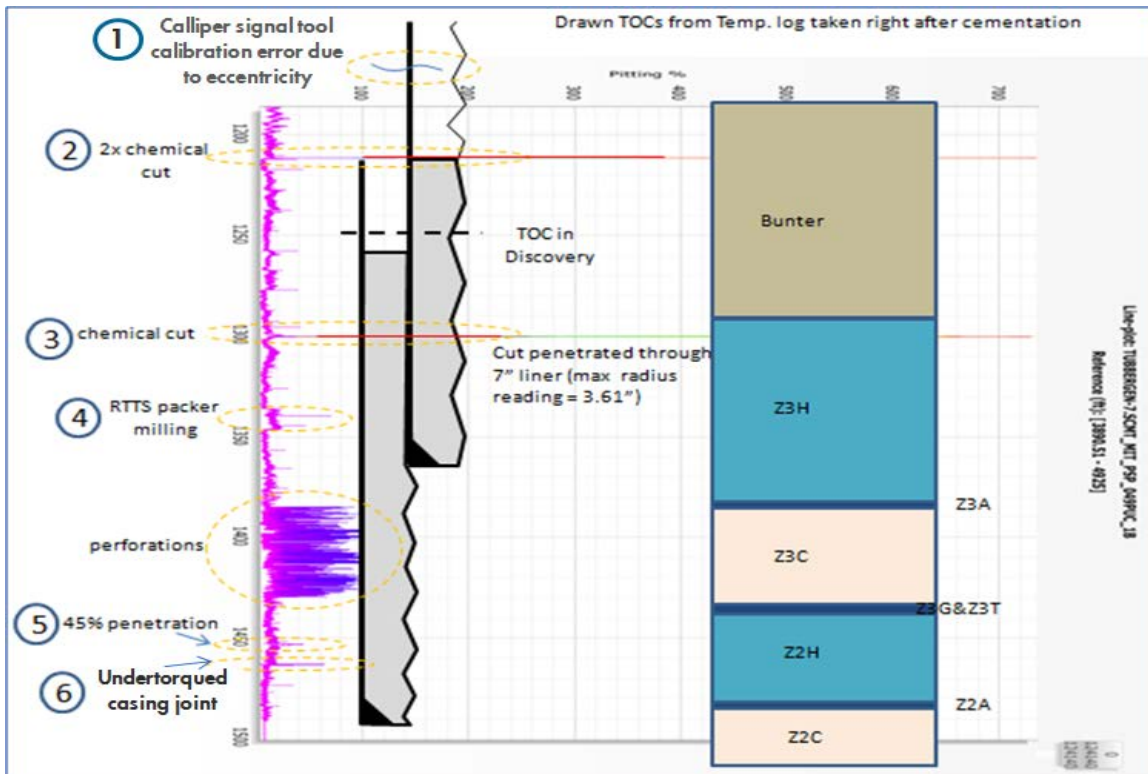

Figure 6 – PMIT-A calliper readings in TUB7

In TUB10 (Attachment 9.6.4) the condition of the production liner underneath the packer was found to be good (maximum pit penetration into the casing is 33% of the original wall thickness). Also the cement bonds across the Carbonate and Halite sections were found to be good. The exception is at 1827 mAHbdf in the ZeZ1T Anhydrite, where a potentially undertorqued casing joint (Figure 7) was observed in combination with a poor cement bond. Considering that the potentially undertorqued casing joint is close to the underlying ZeZ1H formation, a potential risk exists that, in case the joint would leak, injected water might flow behind the liner and expose the ZeZ1H salt. This risk is considered to be small because the cement bond across the ZeZ1H is good (Attachment 9.6.4) preventing flow past the salt. Because of the good cement bond across the layers above the leak, the risk that the injected water might reach the ZeZ2H, also above the suspected joint, is considered unlikely.

Compared to TUB-7 this situation is fundamentally different and has a much lower risk profile. Still, a leak investigation will be carried out in Q1 2015 (when relevant tools are available) by running a PLT/PNDT (noise detection tool) to confirm that water is not leaking-off at the suspected casing joint and to verify presence/absence of flow behind casing.



Figure 7 – 3D-calliper image of potentially undertorqued casing joint in TUB 10 at 1827 mAHbdf. The section shown is about 2.5 m long, the segment with a slight diameter increase is about 15 cm long.

In summary, from a Halite dissolution point of view, all evaluated wells were found to be appropriate for continued water injection except well TUB7. Logging (PLT) suggests a marginal difference in injection rate, i.e., above and below a potentially undertorqued casing joint. Whilst the difference in flow rate is well within the tool accuracy and may also be influenced by a small variation in hole diameter, NAM has taken the precautionary measure to close in the well and is awaiting repair. Whilst the risk level is deemed low, a suspected casing joint in well TUB10 will be further investigated. This well was not shut-in because the risk for injection water to flow past the halite layers below and above the suspected joint is considered low given the good quality good cement bonds observed and the fact that the suspected joint is located in a sump of the well where flow is stagnant.

Injection is continuing as per plan with all risk factors being adequately covered through the prevailing monitoring plan

## 5 Well integrity surveillance and management

### 5.1 Annulus pressure monitoring

Schematic well diagrams for the evaluated wells are presented in Figure 8. These schematics show that most wells have a cemented and perforated casing across the injection reservoir. Only in TUB7 the injection reservoir has been left open hole. Wells ROW4, ROW7, ROW9 and TUB10 are plugged back.

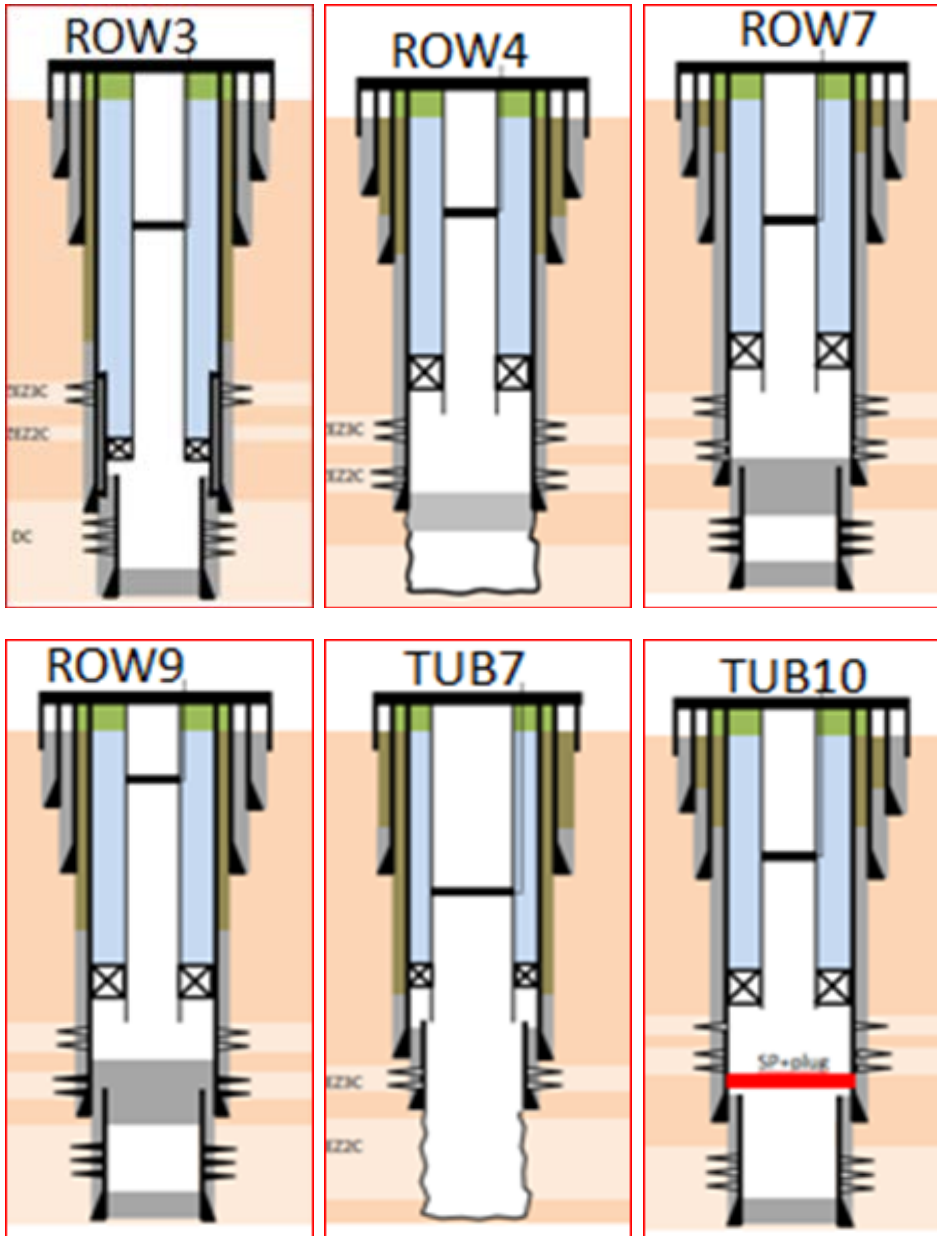

Figure 8 – Well schematics for the water injection wells (ZeZ2C and ZeZ3C represent the Zechstein reservoirs, whereas DC refers to the Carboniferous sandstone reservoir)

The evaluated water injection wells have a carbon steel completion (3½” tubing size, 10.2 lb/ft weight) with a 5000 psi tree. The A-annulus is filled with KCl-brine (1.03 sg), which was circulated into the A-annulus before start water injection. The side-pocket mandrels were equipped with dummy valves after placing the brine. The B- and C-annuli (only present in wells ROW4, ROW9 and TUB10) contain brine or NaCl dolomite mud of varying densities ranging from 1.26 to 1.4 sg. A nitrogen cap was placed in the top of the A- and B-annuli to avoid a vacuum in these annuli when water injection is performed (the cold injection water is expected to cool the annulus content therewith causing a pressure drop in these annuli). Oil has been encountered in the B-annulus of TUB-7. Sampling analysis shows that this oil is not Schoonebeek oil. Most likely source is believed to be the Muschelkalk formation which is exposed to the B-annulus above top of cement.

During the first 3 years of operation all A-, B- and C-annulus pressures have remained below their MAASP (Table 7).

**Table 7 – Comparison MAASP and maximum annulus pressures observed in the first 3 years of injection**

Well	A-annulus		B-annulus		C-annulus	
	MAASP, bar	Pmax, bar	MAASP, bar	Pmax, bar	MAASP, bar	Pmax, bar
ROW3	143	96	21	12	cts*	-
ROW4	192	21	13	8	4	4
ROW7	200	13	12	8	cts*	-
ROW9	179	13	18	11	24	5
TUB7	193	13	7	5	cts*	-
TUB10	162	13	39	6	7	7

\*cts: cemented to surface

## 5.2 Tubing integrity

Figure 9 below shows results of callipers taken in the tubing of the water injection wells in 2009, i.e. before start of water injection, and in 2013 3 years after start injection. It shows the maximum pit penetration (as measured in one or two tubing joints) as percentage of the original wall thickness. The results show that the tubing condition has significantly worsened in wells ROW4 and ROW9, whereas it more or less stayed the same in wells ROW7, TUB7 and TUB10. No tubing calliper was carried-out in ROW3 as this well is shut-in until injection is resumed once the pump envelope is appropriate. When water injection will be resumed a new tubing calliper run will be performed.

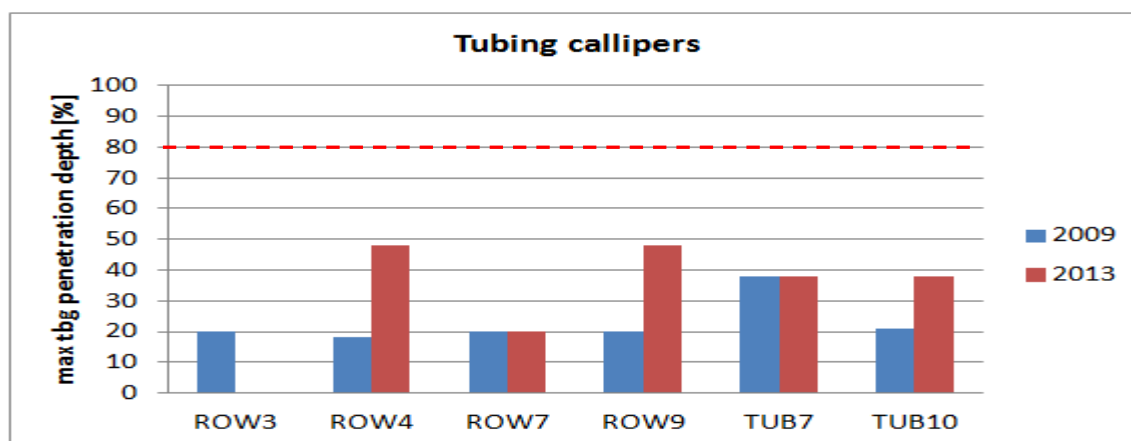

**Figure 9 - Tubing calliper results (max observed pit penetration as % of original wall thickness). The dashed red line indicates the approximate maximum acceptable penetration limit.**

The remaining wall thickness and the required wall thickness to withstand the maximum expected pressure difference across the injection tubing are given in Table 8. The calculations show that all tubings still have enough wall thickness even at maximum injection pressure. Still, to secure sufficient injection capacity in the future, workover might be required in ROW4 and ROW9 to either replace the tubing or to protect the current tubing by installing an insert injection string.

**Table 8 – Current tubing wall thickness compared to required wall thickness**

Well	Max. ΔP across tubing*, bar	Original wall thickness, mm	Minimum wall thickness at start water injection, mm	Current minimum wall thickness, mm	Minimum required wall thickness, mm
ROW3	185	7.3	5.9	-	1.8
ROW4	134	7.3	6.0	3.8	1.3
ROW7	122	7.3	5.9	6.1	1.2
ROW9	143	7.3	5.9	5.9	1.4
TUB7	142	7.3	4.6	4.6	1.4
TUB10	154	7.3	5.8	4.6	1.5

\* at packer depth

A reason for increased pit penetration in wells ROW4 and ROW9 could be due to acid stimulations that have been performed in these wells. During these acid jobs 28% HCl acid was used which could have cleaned the tubing from any debris and oil remain. In ROW4, prior to the acid stimulation, a solvent preflush was applied to clean the tubing, casing and possibly perforations. This may have cleared the way for oxygen corrosion. Oxygen ingress into the tubing likely occurs through the flanges at surface during water injection stops in case the fluid level rapidly drops therewith sucking a vacuum at surface. In principle, oxygen ingress should be prevented by the backpressure valve (BPV) that is installed in the wellhead. However, in numerous wells this BPV appears to have failed. BPVs may easily fail when the oil remnants and debris injected with the water attach on the valve causing the valve to leak.

## 6 Injection water quality

A EURAL (European hazardous waste catalogue) assessment was done during the permit application phase to identify all hazardous chemical components potentially present in the injection water. To compare measured values with the EURAL limits, weekly and monthly sampling and analysis were carried out at the Schoonebeek Central Treatment Facilities (CTF) and at Twente injection wells on an extensive list of parameters (Table 9). This table lists the maximum values of these parameters measured between January 2011 and January 2014. Note that for every respective parameter/ion, the measured maximum values are significantly lower than the EURAL limits. In addition to EURAL, the disposal water is classified as 'non-hazardous' according to the European CLP-Regulation (EC) No 1272/2008<sup>3</sup>.

**Table 9 - Comparison of actual water quality versus EURAL limits**

Parameter	Unit	Sampling frequency	Average value	Expected max. value	Max.value observed	EURAL limit
pH	-	1/wk	5.5 - 6.5	9	6.8	not classified
Total dissolved solids	mg/l	1/mnd	76200	200000	94800	not classified
Total suspended solids >5 µm	mg/l	1/mnd	32	100	69	not classified
Sodium (Na <sup>+</sup> )	mg/l	1/wk	20300	40000	26000	not classified
Magnesium (Mg <sup>2+</sup> )	mg/l	1/wk	795	2500	1100	not classified
Barium (Ba <sup>2+</sup> )	mg/l	1/wk	36	250	48	30000 <sup>3</sup>
Arsene (As)	mg/l	1/mnd	0.002	0.025	0.088	
Mercury (Hg)	mg/l	1/mnd	<0.001	0.005	0.0009	
Hydrogen sulphide (H <sub>2</sub> S) <sup>1</sup>	mg/l	1/wk	-	15		1000
Total iron (Fe <sup>2+</sup> /Fe <sup>3+</sup> )	mg/l	1/wk	19	50	35	not classified
Potassium (K <sup>+</sup> )	mg/l	1/wk	186	1000	880	not classified
Strontium (Sr <sup>2+</sup> )	mg/l	1/wk	486	2500	650	not classified
Chloride (Cl <sup>-</sup> )	mg/l	1/wk	40900	90000	53000	not classified
Sulphate (SO <sub>4</sub> <sup>2-</sup> )	mg/l	1/wk	<19	50	120	not classified
Bicarbonate (HCO <sub>3</sub> <sup>-</sup> )	mg/l	1/wk	370	1000	970	not classified
Carbon dioxide (CO <sub>2</sub> )	mg/l	1/wk	460	500	1200	not classified
Oxygen (O <sub>2</sub> )	mg/l	1/mnd	<0.01	0.05	0.048	not classified
Mineral oil	mg/l	1/mnd	30	100	150	not classified
Cadmium (Cd)	mg/l	1/mnd	<0.001	0.25	0.0054	250000 <sup>3</sup>
Copper (Cu)	mg/l	1/mnd	0.015	1	0.028	
Monoethylene glycol	mg/l	1/mnd	< 200	750	< 400	
Diethylene glycol	mg/l	1/mnd	< 200	750	< 400	
Triethylene glycol	mg/l	1/mnd	< 200	750	< 400	
Ethyl benzene (C <sub>6</sub> H <sub>10</sub> )	mg/l	1/mnd	0.12	0.5	0.17	
Toluene (C <sub>6</sub> H <sub>5</sub> CH <sub>3</sub> )	mg/l	1/mnd	0.85	1	1.6	
Water clarifier <sup>2</sup>	mg/l	1/mnd	0	100	0	
Oxygen scavenger <sup>2</sup>	mg/l	1/mnd	2.5	50	5	
Anti-foamer <sup>2</sup>	mg/l	1/mnd	0.002	0.13	-	
Chrome (Cr)	mg/l	1/mnd	< 0.008	0.25	0.086	1100 <sup>3</sup>
Benzene (C <sub>6</sub> H <sub>6</sub> )	mg/l	1/mnd	1.3	5	4.4	5000
Lead (Pb)	mg/l	1/mnd	< 0.01	2000	0.022	
Nickel (Ni)	mg/l	1/mnd	0.01	500	0.14	10000
Zinc (Zn)	mg/l	1/mnd	0.075	7.5	2.1	50000 <sup>3</sup>
pH controller <sup>2</sup>	mg/l	1/mnd	0	0.28	0	
Biocide+oxygen scavenger <sup>2</sup>	mg/l	1/mnd	1	2.4	1.15	
Scale inhibitor (Ba-scale) <sup>2</sup>	mg/l	1/mnd	13	200		200000 <sup>3</sup>
Calcium (Ca <sup>2+</sup> )	mg/l	1/wk	3695	8000	5000	
Xylene (C <sub>6</sub> H <sub>4</sub> C <sub>2</sub> H <sub>6</sub> )	mg/l	1/mnd	0.32	1	0.54	
Oxygen scavenger <sup>2</sup>	mg/l	1/mnd	2.5	50	5	
Corrosion inhibitor <sup>2</sup>	mg/l	1/mnd	17.2	200	19.5	
H <sub>2</sub> S Scavenger <sup>2</sup>	mg/l	1/mnd	10	120	0.02	not classified
Emulsion breaker <sup>2</sup>	mg/l	1/mnd	0.02	21	-	
<sup>1</sup> Not possible to measure H <sub>2</sub> S in fluid						
<sup>2</sup> Mining chemicals (in yellow rows) concentrations are expressed in mg injected per liter injection water						
<sup>3</sup> EURAL limit refers to sum of concentrations for the grouped parameters						

<sup>3</sup> The CLP-Regulation of the European Parliament and of the Council of 16 December 2008 regarding the Regulation on classification, labelling and packaging of substances and mixtures, amending and repealing Directives 67/548/EEC and 1999/45/EC, and amending Regulation (EC) No 1907/2006.

The table shows that for the vast majority of components the measured values are below the maximum expected values. Only in case of  $\text{SO}_4^{2-}$ ,  $\text{CO}_2$ , oil-in-water, toluene and arsenic, components that are all originally present in the reservoir, slightly higher levels were measured. The trends of these components are shown from start of injection in 2011 until end of 2014 and further discussed below.

- Sulphate

In Figure 10 it can be seen that the sulphate levels are always below the detection limits (~25 mg/l) except twice in 2011. The expected maximum value (50 mg/l) is exceeded only once. The reason for this excursion is unclear. It could be caused by ingress of drilling fluids or oxygen in combination with oxygen scavenger.

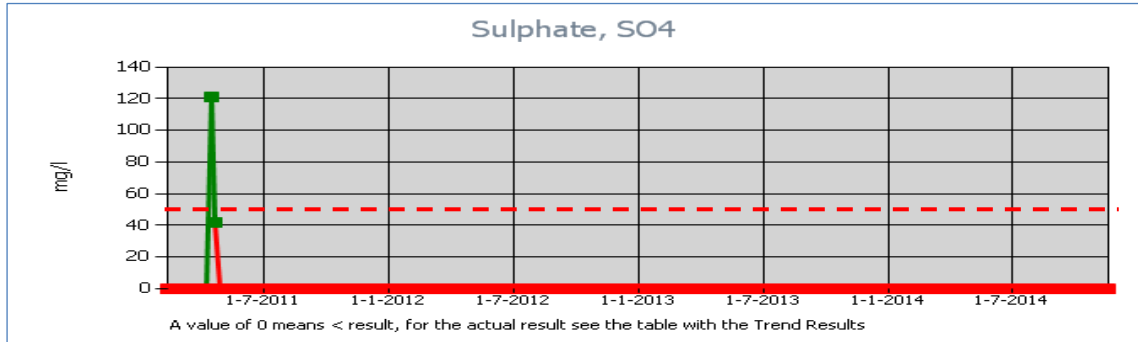

Figure 10 – Sulphate concentration from 2011 until 2014. The dashed red line indicates the expected max. value.

- Carbon dioxide

From Figure 11 it can be seen that the  $\text{CO}_2$  content in injection water is often above the expected maximum of 500 mg/l.  $\text{CO}_2$  originates from the reservoir where the content is even higher than in the disposal water. The  $\text{CO}_2$  partitioning between water and gas in the production system depends on the  $\text{CO}_2$  concentration in the associated gas, temperature, pressure, pH, and residence time in the production system and is difficult to predict. It must be concluded that the expected maximum was set too low.  $\text{CO}_2$  is not included in the EURAL list as it is not harmful in the measured concentrations (reference, sparkling mineral water contains ~5 g/l).

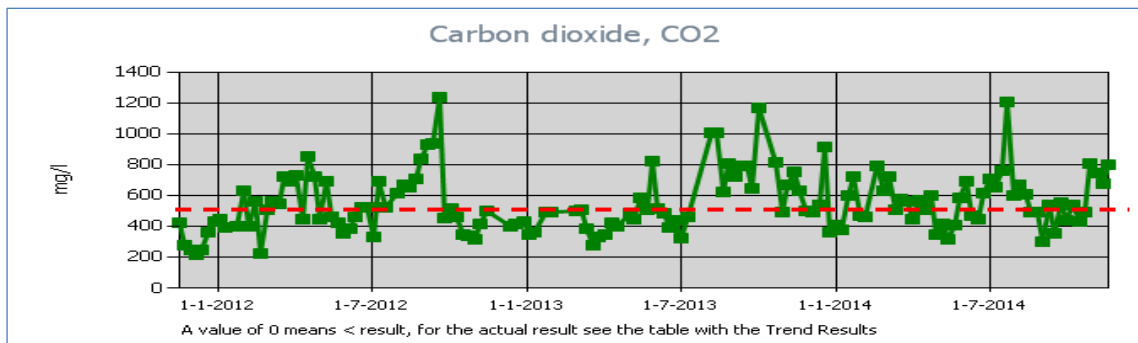

Figure 11 – Carbon dioxide conc. from 2011 until 2014. The dashed red line indicates the expected max. value.

- Mineral oil

The trend is shown in Figure 14. During the start-up of the Schoonebeek field the production process was not fully stable yet and incidentally a higher oil in water content was measured.

Currently the oil in water content is far below the set expected value of 100 mg/l with an average of approximately 15 mg/l. Mineral oil originates from the reservoir.

- Arsenic

Arsenic is a toxic component of the formation water and is normally present in very low concentrations, below its detection limit of 10  $\mu\text{g/l}$ . The maximum expected value is 25  $\mu\text{g/l}$ . On 3 occasions a higher concentration was measured (Figure 12). Arsenic may be released when steam comes in contact with isolated minerals in the reservoir that contain Arsenic (such as certain clay minerals). This may explain the sporadic concentrations above the expected maximum. When setting the expected maximum level, such natural mineral bound excursions were not taken into consideration.

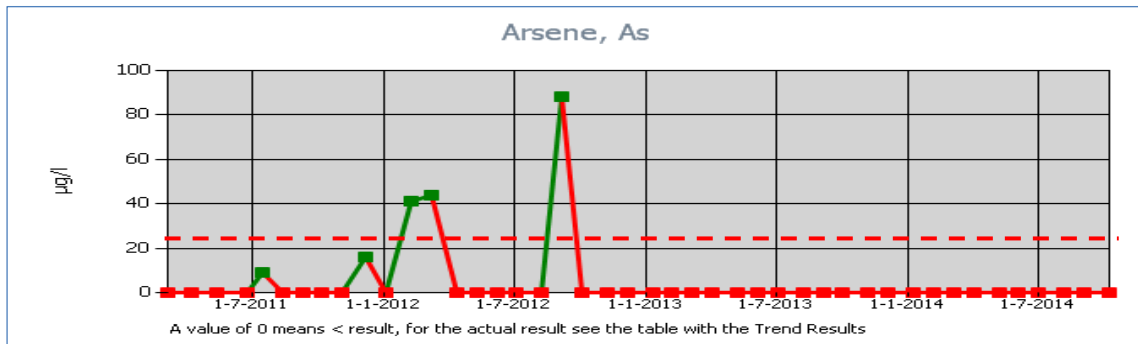

Figure 12 - Arsenic concentration from 2011 until 2014. The dashed red line indicates the expected max. value.

- Toluene

From Figure 13 it is evident that the toluene content in the injection water hovers around the previously expected maximum of 1000 µg/l. Toluene originates from the oil (which contains ~0.1% of toluene) although small amounts can also be present in some processing chemicals as part of the solvents. Toluene partitioning between water, gas and oil in the production system depends on the toluene concentrations, temperature, pressure and residence time in the production system and is, therefore, difficult to predict. The expected maximum concentration was predicted too low.

Toluene is hazardous. However, the observed concentrations are still many orders of magnitude below the EURAL limit (250 million µg/l). Toluene belongs to the group of aromatic compounds. When considering aromatic compounds as a group it is more important to consider Benzene, a highly carcinogenic chemical. The maximum observed Benzene concentration (4400 µg/l) is within the maximum expected concentration (5000 µg/l) and orders of magnitude below the EURAL limit (1 million µg/l).

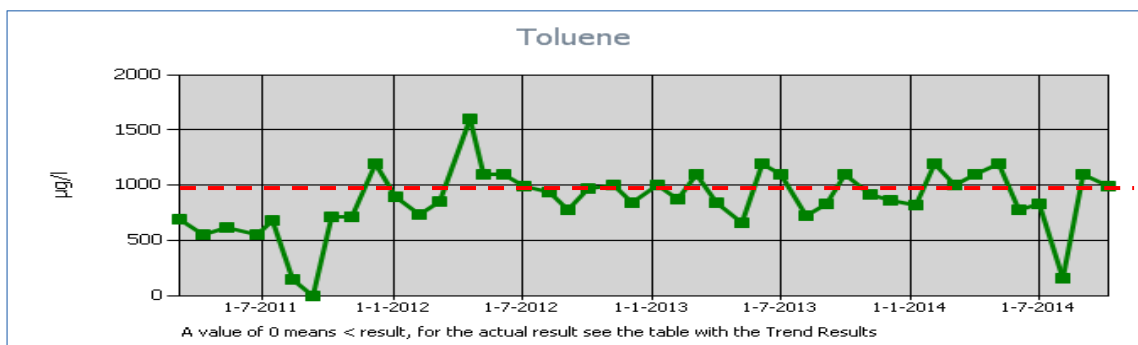

Figure 13 - Toluene concentration from 2011 until 2014. The dashed red line indicates the expected max. value.

Of all monitored parameters, the Chloride level, the oil-in-water concentration and the total suspended solids larger than 5 micron are considered key for ensuring proper management of the water injection activities. Solids content and oil-in water are important parameters as these can cause plugging of the perforations and fracture networks in water injection wells and reservoirs. To avoid excessive plugging, limits have been set, i.e. 100 mg/l for both parameters. Figure 14 shows that so far (period jan11-jan14) the solids and oil content have stayed within these set limits.

The chloride content is an important monitoring parameter as it provides an indication for the amount of condensed steam that is being produced along with the Schoonebeek Oilfield formation water. This condensed steam is expected to dilute all ion concentrations in the Schoonebeek formation water to the same degree. The original chloride content was close to 50,000 mg/l, whereas Figure 14 shows that this concentration has dropped to approximately 35,000 mg/l. Less scale is likely to be formed in the injectors when the ion concentrations decrease.

Besides sampling at the CTF also samples have been obtained at the injection wells, specifically ROW2 and TUB7, in Twente. A comparison between these Twente and CTF samples is given in Table 10 together with the maximum expected levels. From the table it is clear that the parameters measured in Twente remain below the maximum expected level. It also shows that for most parameters the measurements give the same results at the CTF and in Twente. For Benzene, Toluene, Ethylbenzene, Xylene and mineral oil measured concentrations in the fluid samples taken at the water injection wells in Twente are lower than those taken at the CTF. Bicarbonate ( $\text{HCO}_3^-$ ) and  $\text{CO}_2$  also show a deviation. Note herewith that the equilibrium between these 2 components depends a lot on pressure and pH. As pressure and pH can be somewhat different at the CTF compared to Twente this means that the concentrations of  $\text{HCO}_3^-$  and  $\text{CO}_2$ , found in Twente, can be different from those measured at the CTF. Besides,  $\text{CO}_2$  will distribute itself across the fluid and gas phase, whilst  $\text{HCO}_3^-$  can react with Calcium and precipitate to  $\text{CaCO}_3$ .

Table 10 also shows that the oil-in-water concentration, measured in samples at the CTF, exceeds the values measured at the Twente injection wells. The oil-in-water concentration, measured during 2013 at the CTF, varied quite a lot with in the range of 0.7-52mg/l (Figure 14). The oil-in-water concentrations in Twente in this same period fall within this bandwidth. A possible cause for the variation could be contaminations observed in the wells: Common practice for all wells is that wireline interventions are preceded by bullheading 30 m<sup>3</sup> of hot water to clean the tubing, flushing the oil and solids towards the reservoir. On some occasions, however, retrieved wireline tools were covered with a black pasta of solids and oil/wax containing elevated levels of Fe, FeO, S, Ca, Si and CaCO<sub>3</sub>. This suggests that some wells were so dirty that the clean-out was not sufficiently effective and that some of these contaminants could have been back produced. Overall however, the data indicate that that the oil-in-water quality is within allowed limits.

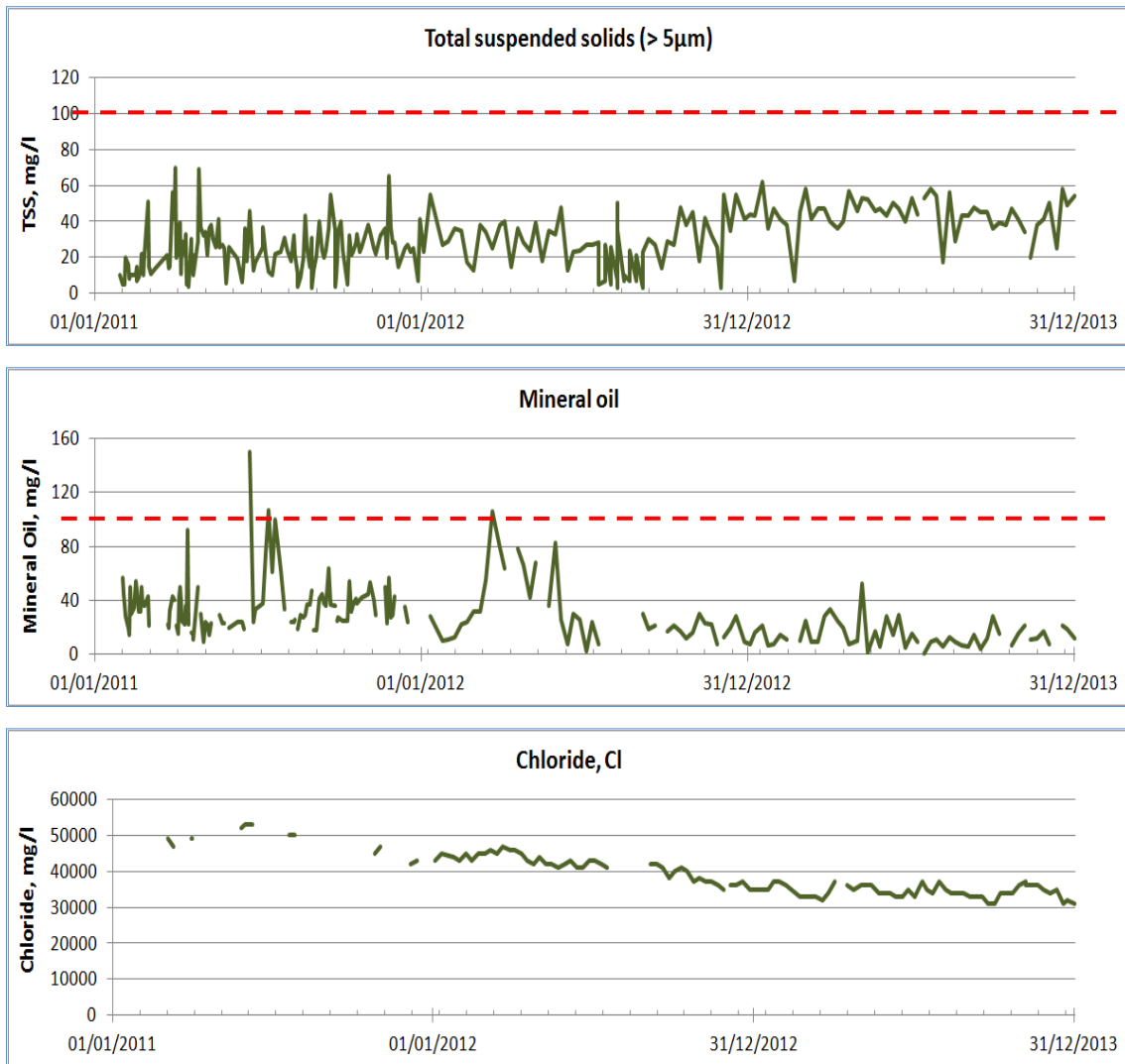

Figure 14 – Suspended solids, oil-in-water and chloride concentrations measured in the injection water at the CTF. The dashed red line indicates the expected max. value. Note that there is no limit for the chloride concentration.



**Table 10 - Water quality comparison between Schoonebeek Central Treatment Facility and 2 wells in Twente (ROW2 en TUB7)**

	TUB7	OBI	ROW2	OBI	gemiddelde verwachte waarde	eenheid	maximaal verwachte waarde	eenheid	Opmerking
Sample Date - Sample Number	26/06/2013 14:55	04/06/2013 11:05	21/03/13 13:40	02/04/13 13:20	Tabel 3 WM aanvraag		Tabel 3 WM aanvraag		
report - NAM reference	SN-2013-06-0712	SN-2013-06-0077	SN-2013-03-0383	SN-2013-04-0014					
Oxygen on-site, O2 (ppb)	<10	<10	< 10	< 10	<10	micro-g/l	50	micro-g/l	
pH	6.7	6.3	6.9	6.3	5.5-6.5	-	4-9	-	
TSS > 5 µm (total sample) (mg/l)		43	70	40	50	mg/l	100	mg/l	
Temperature (deg. C)		22.5	25.1	31.7	35.40	degC	50	degC	
Chloride, Cl (mg/l)	33000	34000	32000	37000	48832	mg/l	90000	mg/l	
Sulphate, SO4 (mg/l)	<13	<15	<13	<15	6.4	mg/l	50	mg/l	
Kalium, K (mg/l)	140	150	150	150	248	mg/l	1000	mg/l	
Sodium, Na (mg/l)	16000	17000	16000	18000	23394	mg/l	40000	mg/l	
Barium, Ba (mg/l)	25	27	28	31					
Calcium, Ca (mg/l)	3000	3100	2900	3400	4675	mg/l	8000	mg/l	
Magnesium, Mg (mg/l)	640	670	630	720	875	mg/l	2500	mg/l	
Strontium, Sr (mg/l)	380	400	380	440	628	mg/l	2500	mg/l	
Iron (total) (mg/l)	15	15	25	15	12	mg/l	50	mg/l	
Arsene, As (µg/l)	<10	<10	<50	<10	2.3	micro-g/l	25	micro-g/l	
Cadmium, Cd (µg/l)	1.2	<1	<5	<1	<100	micro-g/l	250	micro-g/l	
Chrom, Cr (µg/l)	<5	<5	<25	<10	<100	micro-g/l	250	micro-g/l	
Copper, Cu (µg/l)	15	<10	<50	13	<500	micro-g/l	1000	micro-g/l	
Lead, Pb (µg/l)	<10	<10	<50	<10	<1000	micro-g/l	2000	micro-g/l	
Mercury, Hg (µg/l)	0.16	<0.1	0.16	<0.10	1	micro-g/l	5	micro-g/l	
Nikkel, Ni (µg/l)	<10	<10	<50	<10	140	micro-g/l	500	micro-g/l	
Zinc, Zn (µg/l)	<20	<20	<100	<20					
Benzene (µg/l)	510	1300	750	1200	1000	micro-g/l	5000	micro-g/l	
Toluene (µg/l)	420	1200	570	840	560	micro-g/l	1000	micro-g/l	
Ethylbenzene (µg/l)	76	140	87	140	100	micro-g/l	500	micro-g/l	
m/p-Xylene (µg/l)	110	230	150	390					
o-Xylene (µg/l)	86	170	110	150	290	micro-g/l	1000	micro-g/l	
Mineral oil (mg/l)	1.9	28	3.4	33	50	mg/l	100	mg/l	
Methylene glycol, MEG (mg/l)	<50	<100	<100	<100	<500	mg/l	750	mg/l	
Diethylene glycol, DEG (mg/l)	<50	<100	<100	<100	<500	mg/l	750	mg/l	
Triethylene glycol, TEG (mg/l)	<50	<100	<100	<100	<500	mg/l	750	mg/l	
Corrosion Inhibitor CK 941-G (mg/l)	18	20	15	16	15	mg/l	200	mg/l	
Bicarbonate, HCO3 (mg/l)	660	310	510	270	190	mg/l	1000	mg/l	
Carbon dioxide, CO2 (mg/l)	220	520	210	350	100	mg/l	500	mg/l	
Total dissolved solids, TDS (mg/l)	61250	62200	57500	66900	85000-90000	mg/l	200000	mg/l	
emulsiebreker	<0.02 *			<0.02 *	4	mg/l	21	mg/l	berekende jaargemiddelde. Zie ook note 1
anti-schuimmiddel	<0.002 *			<0.002 *	0.02	mg/l	0.13	mg/l	berekende jaargemiddelde. Zie ook note 1
anti-aanslagvloeistof	0				0.05	mg/l	0.24	mg/l	
anti-bariumsulfaat-aanslagvloeistof	13*			13*	30	mg/l	200	mg/l	berekende jaargemiddelde. Zie ook note 2
biocide	0.9 *			0.9 *	0.6	mg/l	2.4	mg/l	berekende jaargemiddelde. Zie ook note 2
zwavelwaterstofbinder	0.01*			0.01*	10	mg/l	120	mg/l	berekende jaargemiddelde. Zie ook note 1
zuurstofbinder	3.6 *			3.6 *	9	mg/l	50	mg/l	berekende jaargemiddelde. Zie ook note 2
pH-regelaar	0			0	0.06	mg/l	0.28	mg/l	
waterreiniger	0			0	6.5	mg/l	100	mg/l	

Note 1: Het betreffende chemical verdeelt zich over de olie en water fase waarbij het merendeel zich in de olie bevindt. De aangegeven concentratie betreft het gedeelte van de chemical dat zich in de water fase bevindt. Deze concentratie is uitgerekend op basis van de verdeel-coëfficiënt (partitioning coefficient) zoals deze bepaald is in laboratorium testen.

Note 2: Het betreffende chemical verdeelt zich over de olie en water fase waarbij het merendeel zich in het water bevindt. De aangegeven concentratie betreft het gedeelte van de chemical dat zich in de water fase bevindt. Deze concentratie is uitgerekend op basis van de verdeel-coëfficiënt (partitioning coefficient) zoals deze bepaald is in laboratorium testen.

Parameter	analysemethode	unit	ROW2				TUB7				OBI			
			01-Aug	08-Aug	15-Aug	22-Aug	01-Aug	08-Aug	15-Aug	22-Aug	30-Jul	06-Aug	13-Aug	20-Aug
pH	ISO-10523	-	5.9	6	6.5	6.4	6.1	6	6.5	6.5	6.5	6.1	6.2	6.2
Natrium	NEN-6442	(mg/l)	19000	18000	17000	18000	18000	17000	18000	17000	18000	18000	17000	17000
Calcium	ISO-14911	(mg/l)	3400	3300	3100	3200	3100	3000	3300	3100	3400	3300	3100	3100
Magnesium	ISO-14911	(mg/l)	690	670	630	660	660	650	670	630	690	660	630	650
Barium	ISO-14911	(mg/l)	30	29	30	31	31	27	31	35	30	31	31	30
ijzer (Fe2+ en Fe3+)	volgens NAM procedure W081 (NAM is geaccrediteerd volgens ISO-17025)	(mg/l)	15	20	20	15	15	15	15	15	20	20	20	15
Kalium	NEN 6442	(mg/l)	150	150	150	150	150	150	150	160	150	150	150	150
Strontium	ISO 14911	(mg/l)	420	410	390	400	400	390	410	390	420	400	390	400
Chloride	NEN-6476	(mg/l)	37000	36000	34000	35000	35000	34000	36000	34000	37000	35000	34000	34000
Sulfaat	ASTM D516	(mg/l)	<15	<15	<15	<15	<15	<15	<15	<15	<15	<15	<15	<15
Bicarbonaat	volgens NAM procedure W351 (NAM is geaccrediteerd volgens ISO-17025)	(mg/l)		740	600	1100		240	640	800		970	480	380
Koolstofdioxide	volgens NAM procedure W351 (NAM is geaccrediteerd volgens ISO-17025)	(mg/l)		490	320	73		980	210	130		1000	1000	620
Sulphide	volgens NAM procedure SAM011 (NAM is geaccrediteerd volgens ISO-17025)	(mg/l)	2.5	3	1.5	1.5	2.5	3	2.5	1.5	1.5	3	1	2

**Table 11 - Solids samples taken from various points in the water injection system**

Well	Sample location	Date	Component	Acid solubility	Sample number
ROW7	strainer	jan-11	mainly ironoxide - some FeS		SN20110100202
ROW2	filter flowline	june-12	mainly oil - some iron, CaSO3, clay		SN2012060264
ROW2	1210m depth	nov-12	88% oil + 12% Fe, S, Ca, Si	76% acid soluble	SN2013050731
ROW7	20m depth	nov-12	84% oil + 16% Si, Fe	58% acid soluble	SN2013050732
ROW3	?	?	crude oil		
ROWC-ROW6	pipeline	feb-13	black sludge (16% Fe) + plastic		SN2013020184
TUB5-TUB7	pipeline	jan-13	black sludge (6% Fe)		SN2013020185
TUM1	dummy run	oct-12	black pasta - Fe, organic sulphur, mainly oil		SN2012100412
TUM1	meter at surface	mar-12	mainly ironoxide, Fe + Ca	can be dissolved in WD1000/acid	SN2012030389
TUM2	valve at surface	apr-11	magnetic alloy of oxidized Fe and Cr		SN2011040202
TUM3	w/l dummy run	nov-12	oil + bit of Fe and organic sulphur		SN2012100416
TUM2	filter flowline	aug-13	oil + Si, Fe	24% acid insoluble	SN2013100368
ROW7	w/l EMIT run	Feb-14	will be reported on 1April14		

## 7 Surveillance plan

Yearly a monitoring plan is executed to monitor the performance of the Twente water injection wells and reservoir to timely identify and mitigate well/reservoir integrity issues. The frequency of the various surveillance activities has been reviewed based on the surveillance findings obtained so far. The resulting surveillance plan is given in Table 12. Surveillance activities indicated in red still need to be executed. Hence, the static pressure survey in ROW9 will be carried out in Q4 2014. Activities indicated in grey will be cancelled. The last static pressure survey in ROW3 was carried-out in November 2013. Since then the well has been mainly shut-in and, therefore, the reservoir pressure will not have changed significantly. The logging requirements for well TUB10 will be re-assessed (ref. page 14).

According to the SRT-data presented in Table 4 it appears that every subsequent year the required time to execute a valid SRT becomes longer. Before start water injection it appears that the injection pressures stabilized within hours whereas after 3 years of testing injection rate steps need to last for weeks to ensure stabilization. For that reason it is expected that SRT's in wells ROW7 and ROW9 can take 1-2 months each to complete. In practice, because of required available injection capacity, scheduling and executing SRT's becomes increasingly difficult with a risk of poorer data quality. Furthermore, it is clear from the SRT results that, for the fractured Zechstein Carbonate reservoirs, no slope change will be observed that indicates fracturing the reservoir seal. Injection pressures will still be closely monitored to stay below the set THP limit to avoid fracturing the reservoir seal. Injectivity will be derived comparing injection (i.e. pump) rates and injection pressure in time, regularly. Therefore, it is intended to focus surveillance, in particular injection pressure and rate, more on monitoring static reservoir pressure by means of static surveys and less on monitoring well injectivity by means of SRTs and fall-offs.

**Table 12 - Surveillance plan for period 2014-2016**

Well	Comments	2012				2013				2014				2015				2016			
		Q1	Q2	Q3	Q4	Q1	Q2	Q3	Q4	Q1	Q2	Q3	Q4	Q1	Q2	Q3	Q4	Q1	Q2	Q3	Q4
ROW3	Well has been long term shut-in. No need to run SPTG survey in 2014. Surveillance will be executed when injection is resumed. Surveillance will be executed when CBL not possible to run due to cemented straddle.			T					S/T				S								
ROW4				T					CBL/C/SRT	S				S/SRT/T/ CBL/C				S/T			
ROW7				T	S/SRT					C		S/T/SRT				S/T		CBL/C		S/T	
ROW9	SPTG will be executed in Q4 2014 CBL and caliper to be run in 2018			T		S/SRT							S/T/SRT				S/T				S/T
TUB7	Multiple potential leaks encountered. Well is shut-in until repaired. Surveillance will be resumed thereafter.											T/S/PLT		S/T				S/T/ SRT			
TUB10	Possible unscrewed casing. Execute PNDT (if the tool is available) in Q1 2015			T								S/SRT		S/T/SRT PNDT or PLT+T				S/T			

T = temperature survey, S = static pressure survey, SRT = step-rate test, C = caliper survey, CBL = cement bond log

## 8 Conclusions

Schoonebeek production water is injected into depleted gas reservoirs in Twente. Because of the, in the Schoonebeek FDP, assumed high plateau rate of 12,500 m<sup>3</sup>/d it was agreed with the authorities to share the injection data and evaluate injection performance and injection models. As specified in the Water Injection Management Plan, a 3-yearly review was carried-out for the following injection wells: ROW3, ROW4, ROW7, ROW9, TUB7 and TUB10. Regarding the water injection volumes the following is concluded:

- The actual total injection rate has only been 4,000-5,000 m<sup>3</sup>/d, which is due to lower performance of Schoonebeek Oilfield production wells.
- Almost 80% of the total injected volume has mainly been injected into 5 wells ROW2, ROW7, ROW9, TUB7 and TUB10.

The evaluation has focused on the injection performance (pressure and injectivity), actual reservoir pressures as compared to the model, casing integrity to identify potential threats of near-wellbore Halite dissolution, well and tubing integrity, as well as on the injection water quality

The following is concluded regarding the injection performance of the evaluated wells:

- The actual surface injection pressures remain well below the set THP-limits, defined to avoid potential fracturing into the overlying reservoir seal.
- During the first 3 years of injection the local reservoir pressure has stayed relatively low in wells ROW7, TUB7 and TUB10 and do match the pressure prediction curve.
- In wells ROW3, ROW4 and ROW9 an increase in reservoir pressure is observed. For ROW3 the well is connected to a smaller reservoir compartment in comparison to the produced gas volume. For ROW4 and ROW9 the reservoir pressure is higher than predicted, but shows a decreasing trend (ROW4) or at least remained constant (ROW9).
- Fall-off surveys have been conducted that indicate that ROW4 and ROW9 have a low fracture density preventing the water to travel as far through the formation as gas could during the production phase resulting in a rapid pressure build-up near the injection wells.
- Step-rate tests clearly show, by the slope-change, that controlled formation breakdown occurred only in ROW3, the only well injecting into the Carboniferous Sandstone reservoir. For the other wells, where water is injected into the fractured Zechstein Carbonate reservoir, the SRT-plots all show a linear trend indicating injection into existing fractures.
- The injectivity in wells ROW7, TUB7 and TUB10 is still considered very high, whereas in wells ROW4 and ROW9 it appears to be moderate, but constant.
- The injectivity in ROW3 is very poor due to the fact that the Carboniferous sandstone reservoir for this well does not contain a natural fracture network. Formation breakdown was observed during an injection test in 2009 but the resulting fracture(s) is (are) not propagated.
- Quality of step-rate test results is relatively poor as it takes longer to achieve downhole pressure stabilization every subsequent year. Besides, for wells that do not completely fill up to surface, it appears not possible to judge from the surface pressure whether stable downhole pressure was achieved.

Extensive modelling has indicated that significant Halite dissolution can only be expected near the injection well. In order to facilitate this injection water has to be able to directly flow past Halite formation. This requires a combination of a leak in the production casing and a poor cement bond behind the casing. Consequently, temperature surveys, cement bond logging and casing calliper surveys were executed to detect injection water exposing Halite. From the logging the following is concluded:

- The temperature surveys indicate that injection occurs into the Zechstein reservoirs and not in the Halite formations.
- Temperature surveys do not show temperature anomalies that could be indicative for significant leakage to Halite (a relatively small volume may not cause sufficient cooling to be detected by temperature logging).
- The risk to dissolve salt (Halite) is perceived low in all logged wells, but TUB7 and TUB10 where the risk level is assessed at low to medium:
  - In TUB7 the casing calliper results show that the casing integrity is compromised at several depths potentially exposing Halite at the Ze2H and Ze3H to injection water.
  - Temperature surveys and cement bond log in the well suggest that it is not likely that significant salt dissolution has occurred.
  - In TUB10 a potentially undertorqued casing joint in combination with a poor cement bond was found at the level of the ZeZ1T Anhydrite just above the ZeZ1H Halite formation. The risk that the ZeZ1H below and ZeZ2H above the suspect joint might be exposed to injection water is considered low because both salt zones show good cement bonds which would prevent flow behind casing.

Evaluation of the well and tubing integrity show that:

- During the first 3 years of operation all A-, B- and C-annulus pressures have remained below their MAASP.
- Tubing strength calculations show that all tubings still have enough wall thickness to withstand maximum injection pressures.
- ROW4 and ROW9 have been acid stimulated, which may have caused increased pitting.

Weekly and monthly sampling and analysis have been carried out at the Schoonebeek Central Treatment Facilities (CTF) and at Twente injection wells on an extensive list of parameters. From the analysis it is concluded that:

- For all parameters the maximum expected and measured level for every respective parameter/ion is significantly lower than the EURAL limit.
- For the vast majority of parameters the measured values are below the maximum expected values. For  $\text{SO}_4^{2-}$ ,  $\text{CO}_2$ , oil-in-water, toluene and arsene higher levels were measured occasionally.
- The parameters measured in Twente, specifically at ROW2 and TUB7, give the same results than at the CTF for most parameters.

The water injection surveillance plan was executed according plan. Reviewing the results and execution of the surveillance activities have resulted in the following deviations:

- Step-rate test that were planned in Q3-4 this year are cancelled for wells ROW7 and ROW9. Experience with step-rate tests on other wells have shown that they do not provide the desired data on a timely basis and with sufficient accuracy to be of use as a viable monitoring tool going forward.
- For the same reason, it is proposed to cancel future step-rate tests.
- Surveillance in ROW3 will be carried out once water injection will be resumed.
- Logging requirements in TUB10 will be executed in Q1 2015.

## 9 Attachments

### 9.1 Overview of annual reported water injection data

ROW3		2011	2012	2013
Pompdruk	bar	0-163	0-168	0-168
Pompdruklimiet	bar	180	180	180
Huidige reservoir druk	bar	109 (28d)	122 (22d)	142 (5d)
Reservoir druk bij aanvang water injectie	bar	71	71	71
Originele reservoir druk (voor aanvang gas productie)	bar	199	199	199
Geplande uiteindelijke reservoir druk na injectie (FDP plan)	bar	188	188	188
Verwachte reservoir druk aan einde injectiejaar	bar	71	71	72
Maximale injectiedebiet	m3/d	1000	700	700
Maximaal geplande injectiedebiet (FDP plan)	m3/d	1200	1200	1200
Jaarlijks cumulatief geïnjecteerd volume	mIn m3	0.0148	0.0094	0.0102
Jaarlijks cumulatief geïnjecteerd volume (FDP plan)	mIn m3	0.4380	0.4380	0.4380
Uiteindelijk cumulatief geïnjecteerd volume (FDP plan)	mIn m3	2.23	2.23	2.23
Totale opslagcapaciteit reservoir	mIn m3	2.8	2.8	2.8
Huidige vullingsgraad	%	0.5	0.9	1.2
Uiteindelijke vullingsgraad (FDP plan)	%	80	80	80

ROW4		2011	2012	2013
Pompdruk	bar	0-94	0-113	0-116
Pompdruklimiet	bar	131	131	131
Huidige reservoir druk	bar	47 (3d)	37 (6d)	
Reservoir druk bij aanvang water injectie	bar	8	8	8
Originele reservoir druk (voor aanvang gas productie)	bar	150	150	150
Geplande uiteindelijke reservoir druk na injectie (FDP plan)	bar	81	81	81
Verwachte reservoir druk aan einde injectiejaar	bar	8	8	8
Maximale injectiedebiet	m3/d	2000	2140	2220
Maximaal geplande injectiedebiet (FDP plan)	m3/d	2500	2500	2500
Jaarlijks cumulatief geïnjecteerd volume	mIn m3	0.0508	0.0598	0.1351
Jaarlijks cumulatief geïnjecteerd volume (FDP plan)	mIn m3	0.9125	0.9125	0.9125
Uiteindelijk cumulatief geïnjecteerd volume (FDP plan)	mIn m3	3.83	3.83	3.83
Totale opslagcapaciteit reservoir	mIn m3	5.03	5.03	5.03
Huidige vullingsgraad	%	1.0	2.2	4.9
Uiteindelijke vullingsgraad (FDP plan)	%	76	76	76

ROW7		2011	2012	2013
Pompdruk	bar	0-11	0-10	0-10
Pompdruklimiet	bar	119	119	119
Huidige reservoir druk	bar	11 (41d)	11 (12d)	11 (2d)
Reservoir druk bij aanvang water injectie	bar	12	12	12
Originele reservoir druk (voor aanvang gas productie)	bar	150	150	150
Geplande uiteindelijke reservoir druk na injectie (FDP plan)	bar	36	36	36
Verwachte reservoir druk aan einde injectiejaar	bar	13	14	16
Maximale injectiedebiet	m3/d	2100	1800	1800
Maximaal geplande injectiedebiet (FDP plan)	m3/d	1800	1600	700
Jaarlijks cumulatief geïnjecteerd volume	mIn m3	0.1006	0.1682	0.2311
Jaarlijks cumulatief geïnjecteerd volume (FDP plan)	mIn m3	0.6570	0.5840	0.2555
Uiteindelijk cumulatief geïnjecteerd volume (FDP plan)	mIn m3	1.48	1.48	1.48
Totale opslagcapaciteit reservoir	mIn m3	2.6	2.6	2.6
Huidige vullingsgraad	%	3.9	10.3	19.2
Uiteindelijke vullingsgraad (FDP plan)	%	74	74	74

ROW9		2011	2012	2013
Pompdruk	bar	0-69	0-38	0-30
Pompdruklimiet	bar	139	139	139
Huidige reservoir druk	bar	26 (7d)	27 (14d)	29 (3d)
Reservoir druk bij aanvang water injectie	bar	11	11	11
Originele reservoir druk (voor aanvang gas productie)	bar	150	150	150
Geplande uiteindelijke reservoir druk na injectie (FDP plan)	bar	58	58	58
Verwachte reservoir druk aan einde injectiejaar	bar	11	12	13
Maximale injectiedebiet	m3/d	1700	1350	1700
Maximaal geplande injectiedebiet (FDP plan)	m3/d	1350	1350	900
Jaarlijks cumulatief geïnjecteerd volume	mln m3	0.0618	0.1487	0.1452
Jaarlijks cumulatief geïnjecteerd volume (FDP plan)	mln m3	0.4928	0.4928	0.3285
Uiteindelijk cumulatief geïnjecteerd volume (FDP plan)	mln m3	1.61	1.61	1.61
Totale opslagcapaciteit reservoir	mln m3	2.3	2.3	2.3
Huidige vullingsgraad	%	2.7	9.2	15.5
Uiteindelijke vullingsgraad (FDP plan)	%	70	70	70

TUB7		2011	2012	2013
Pompdruk	bar	0	0-13	0-13
Pompdruklimiet	bar	139	139	139
Huidige reservoir druk	bar	6 (2d)	7 (7d)	7 (99d)
Reservoir druk bij aanvang water injectie	bar	6	6	6
Originele reservoir druk (voor aanvang gas productie)	bar	211	211	211
Geplande uiteindelijke reservoir druk na injectie (FDP plan)	bar	103	103	103
Verwachte reservoir druk aan einde injectiejaar	bar	6	6	7
Maximale injectiedebiet	m3/d	2000	2270	2270
Maximaal geplande injectiedebiet (FDP plan)	m3/d	2000	2000	2000
Jaarlijks cumulatief geïnjecteerd volume	mln m3	0.0586	0.2980	0.2164
Jaarlijks cumulatief geïnjecteerd volume (FDP plan)	mln m3	0.7300	0.7300	0.7300
Uiteindelijk cumulatief geïnjecteerd volume (FDP plan)	mln m3	4.65	4.65	4.65
Totale opslagcapaciteit reservoir	mln m3	6	6	6
Huidige vullingsgraad	%	1.0	5.9	9.5
Uiteindelijke vullingsgraad (FDP plan)	%	77.5	77.5	77.5

TUB10		2011	2012	2013
Pompdruk	bar	0	0-15	0-18
Pompdruklimiet	bar	150	150	150
Huidige reservoir druk	bar	7 (2d)	9 (19d)	13 (16d)
Reservoir druk bij aanvang water injectie	bar	6	6	6
Originele reservoir druk (voor aanvang gas productie)	bar	211	211	211
Geplande uiteindelijke reservoir druk na injectie (FDP plan)	bar	52	52	52
Verwachte reservoir druk aan einde injectiejaar	bar	6	7	7
Maximale injectiedebiet	m3/d	2000	2000	2500
Maximaal geplande injectiedebiet (FDP plan)	m3/d	2000	2000	2000
Jaarlijks cumulatief geïnjecteerd volume	mln m3	0.0947	0.3614	0.2667
Jaarlijks cumulatief geïnjecteerd volume (FDP plan)	mln m3	0.7300	0.7300	0.7300
Uiteindelijk cumulatief geïnjecteerd volume (FDP plan)	mln m3	5.11	5.11	5.11
Totale opslagcapaciteit reservoir	mln m3	6.72	6.72	6.72
Huidige vullingsgraad	%	1.4	6.8	10.8
Uiteindelijke vullingsgraad (FDP plan)	%	76	76	76

## 9.2 Reservoir pressure development during injection

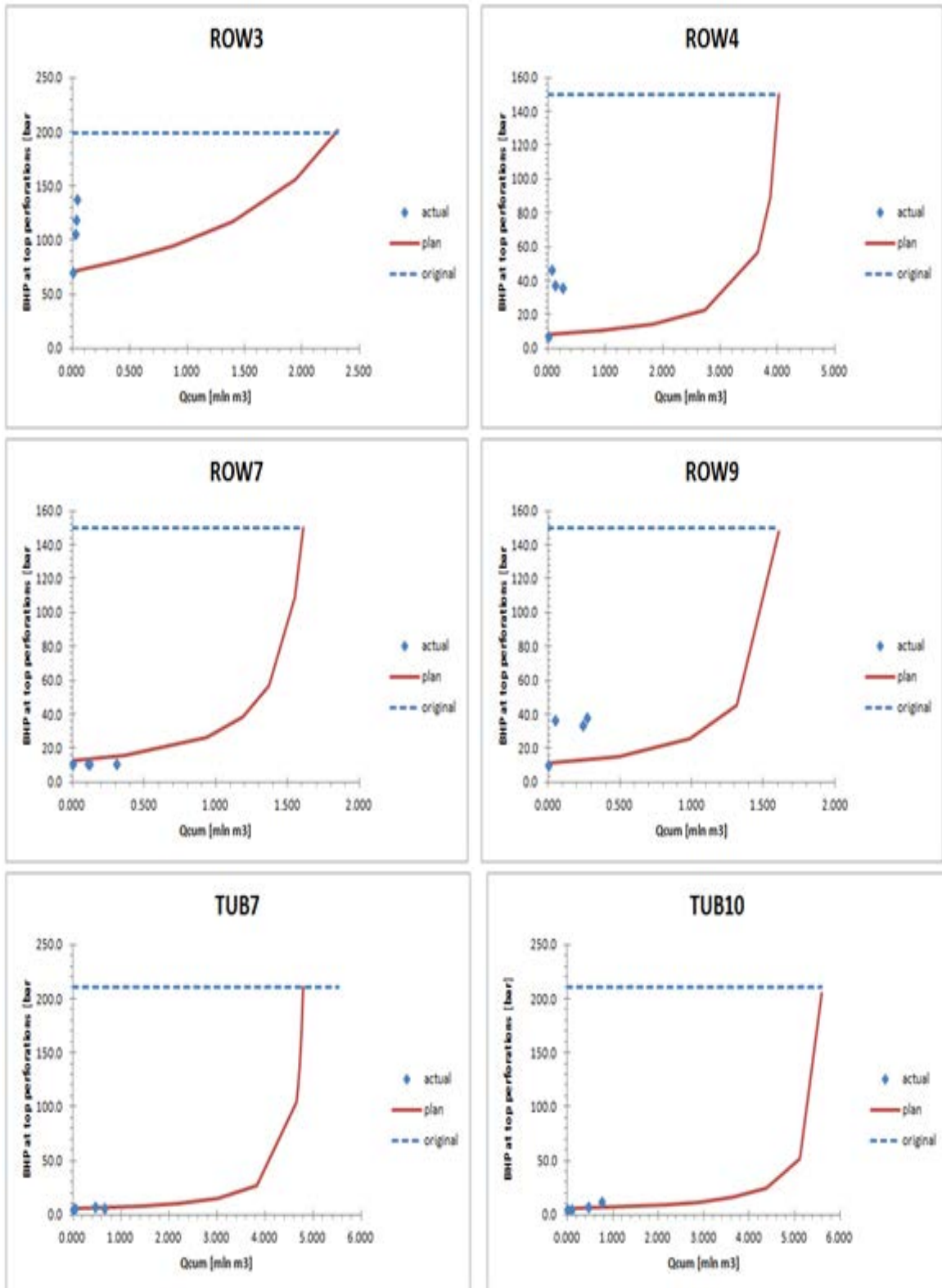

### 9.3 Step-rate test results

Note: all measured flowing bottomhole pressures (FBHP) at gauge depth have been recalculated to top reservoir.

#### 9.3.1 Well ROW3

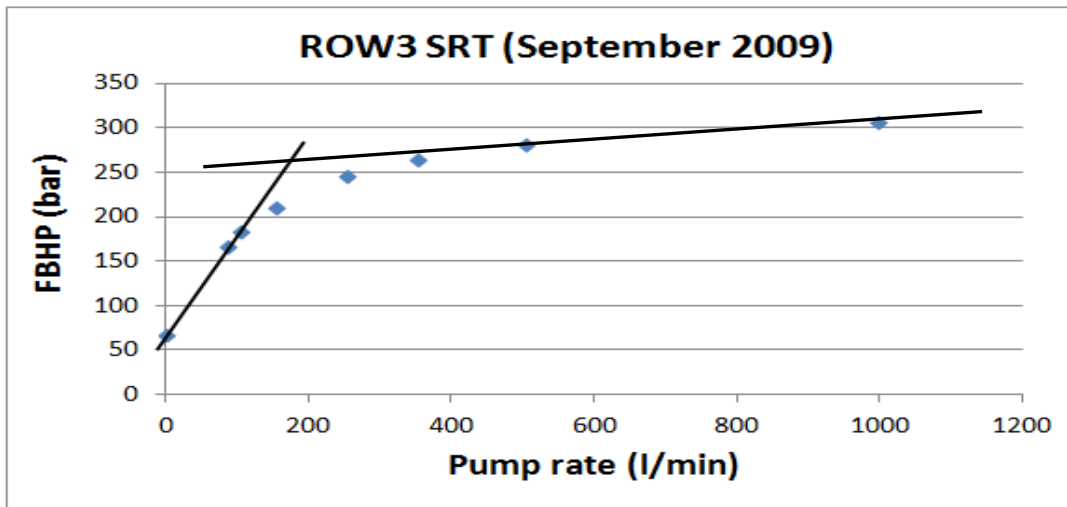

#### 9.3.2 Well ROW4

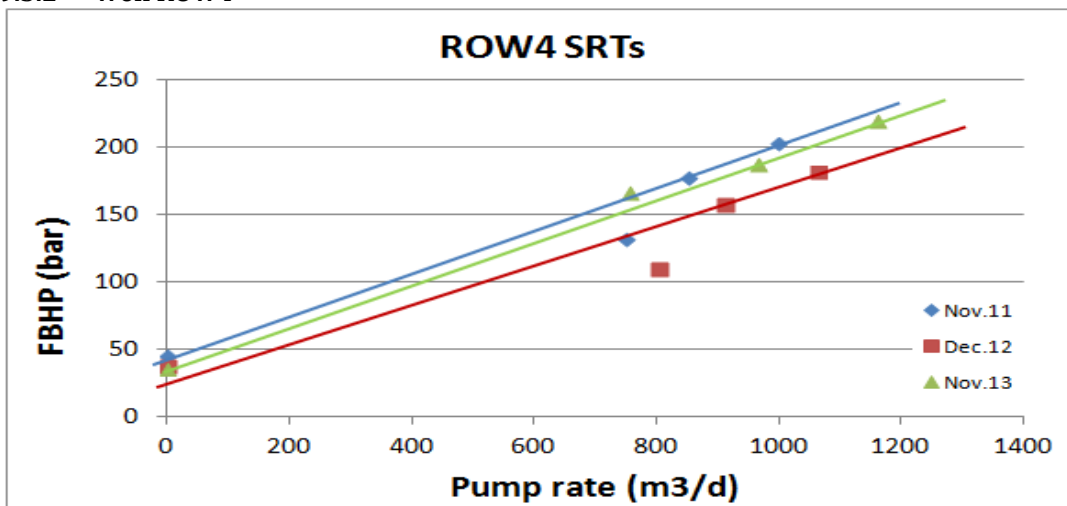

#### 9.3.3 Well ROW7

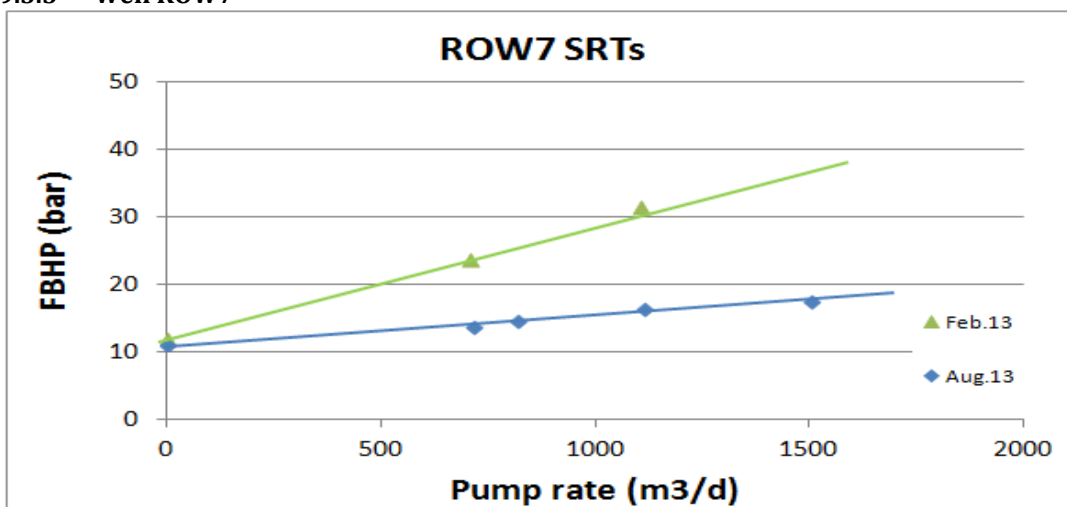



9.3.4 Well ROW9

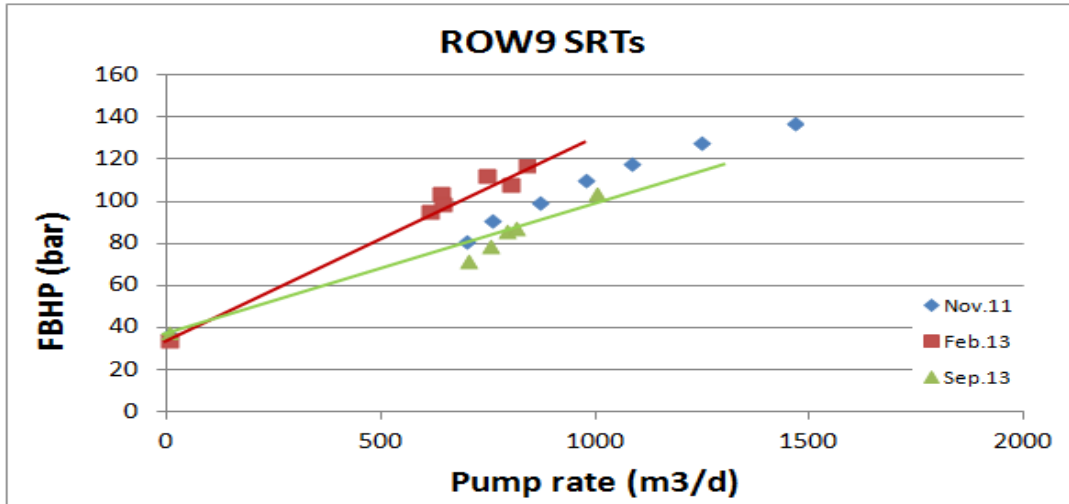

9.3.5 Well TUB10

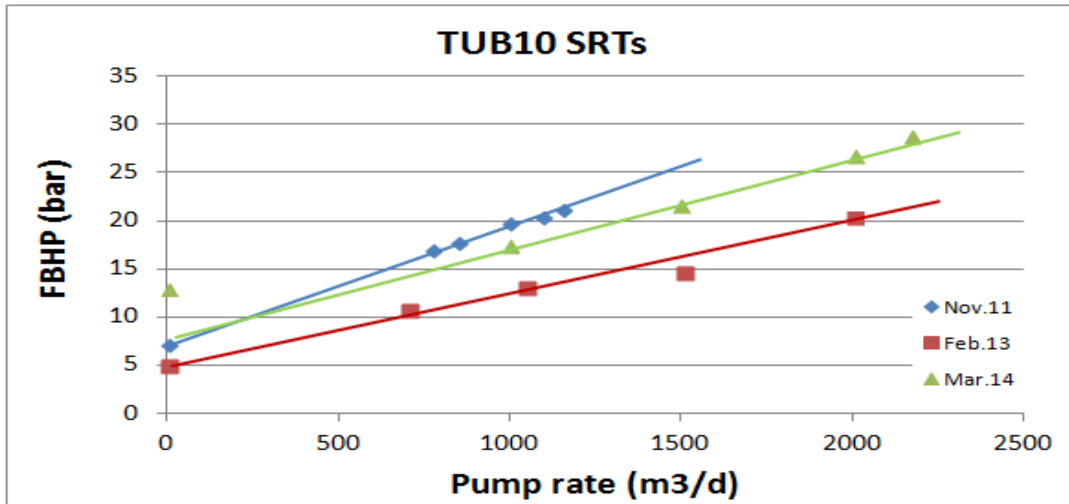

## 9.4 Description of potential salt dissolution risk

The injection water is under-saturated with salt, whereas the salinity will decrease as time progresses due to condensed steam breaking through from the steam injection wells to the production wells. This means that the injection water has a significant capacity to dissolve salt. This salt dissolution capacity poses a potential risk in the injection wells where the injection reservoir is surrounded by Halite (i.e. salt) formations as is the case for the TUB and ROW fields.

To assess the salt dissolution risk, modelling was performed by Shell P&T in Rijswijk. From that study it was concluded that significant salt dissolution can only occur in case low saline injection water is able to flow past Halite rock, i.e. the fluid velocity at the Halite-water interface must be sufficient to avoid that the salt concentration in the water reaches saturation level locally. A review, made of the injection well design and the injection reservoir geology, identified the following 2 cases where such a “Halite flow past scenario” can occur:

### 1. Near-wellbore cases

Near the injection well a hydraulic connection can exist between the Carbonate reservoir and the overlying Halite seal via cracks in the production casing cement. In case these cement cracks line up with any potential holes in the casing, e.g. caused by potential corrosion, then this could allow flow past the Halite allowing halite dissolution (Figure 15).

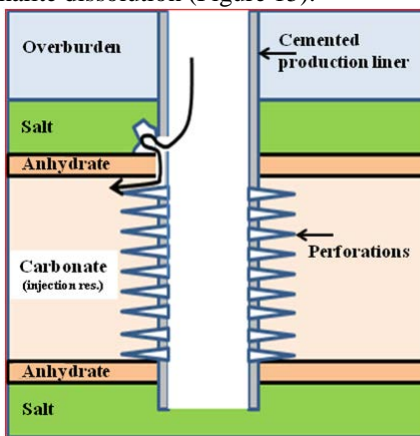

Figure 15 – Near-wellbore salt dissolution scenario in case hole in casing lining-up with the Halite formation

### 2. Far-field cases

In unfaulted areas, contact between the injection water and Halite formations is highly unlikely in view of the presence of continuous anhydrite layers, which shield off the Carbonate injection reservoir from the over- and underlying Halite formations. In faulted areas Halite rock can be juxtaposed against the Carbonate injection reservoir provided the fault offset exceeds the thickness of the over/underlying anhydrite formation (Figure 16).

In a faulted area a “Halite flow past scenario” could occur when (i) injection water flows laterally from the injection well to juxtaposed Halite rock where it can dissolve the Halite and (ii) in a faulted area at the down-dip flanks of the injection reservoir. In the first case, to sustain any dissolution, the water needs to flow vertically away from the Halite/Carbonate interface in order to allow a continuous supply of relatively fresh (low saline) water towards the exposed Halite rock. In the second case, when low saline water collects in the down-dip flanks over time, a convection loop could occur where injection water dissolves overlying Halite rock. Due to gravitational forces, salty water settles allowing relatively lighter injection water to rise from the bottom of the injection reservoir to the exposed overlying Halite rock.

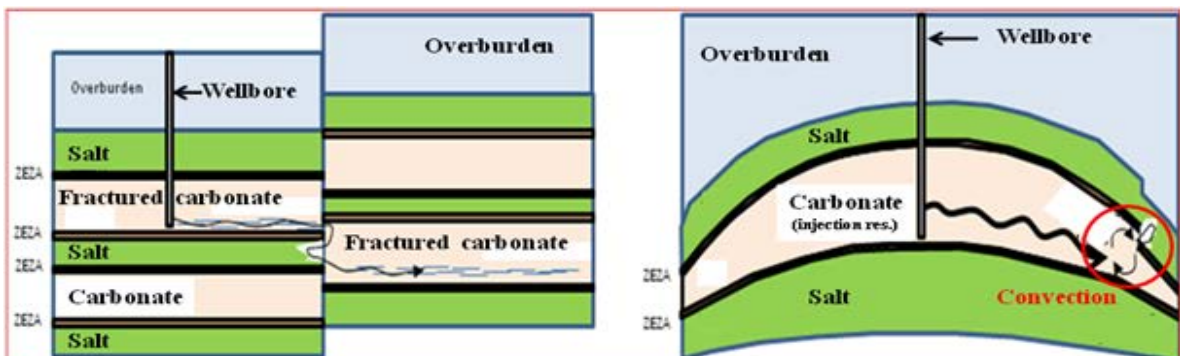
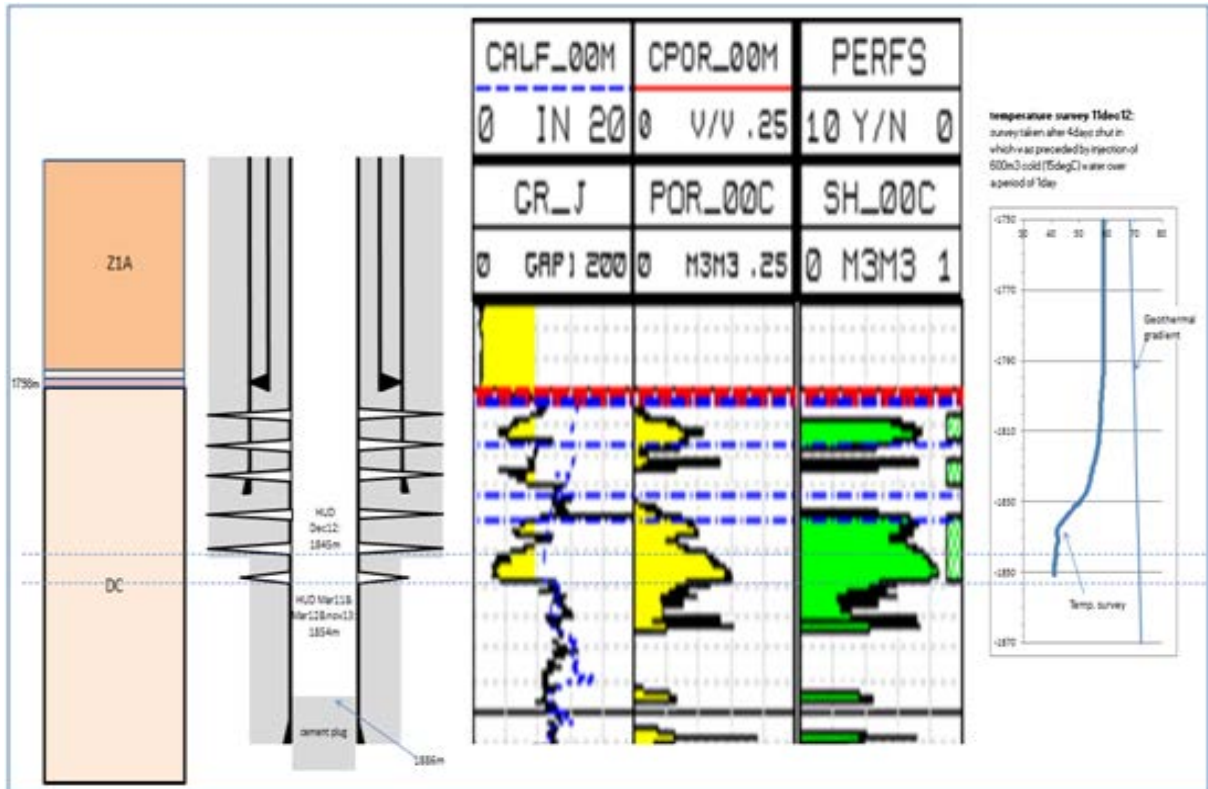

Figure 16 – Far field halite dissolution scenarios in case of juxtaposition (left) and convection (right). Note that the carbonate reservoir is separated from the salt layers by a thin anhydrite layer.

The Halite dissolution modelling results showed that in the far-field, fluid velocities are too small to cause significant Halite dissolution. This is because the vertical communication within the injection reservoir is very low ( $k_v/k_h$  ratio is in the order of  $10^{-3}$  to  $10^{-4}$ , EP201310201845). Any low saline water reaching Halite rock, exposed to the injection reservoir due to faulting, therefore cannot flow away fast enough from the Halite to cause any significant dissolution rate.

## 9.5 Temperature logging results

### 9.5.1 Well ROW3



### 9.5.2 Well ROW4

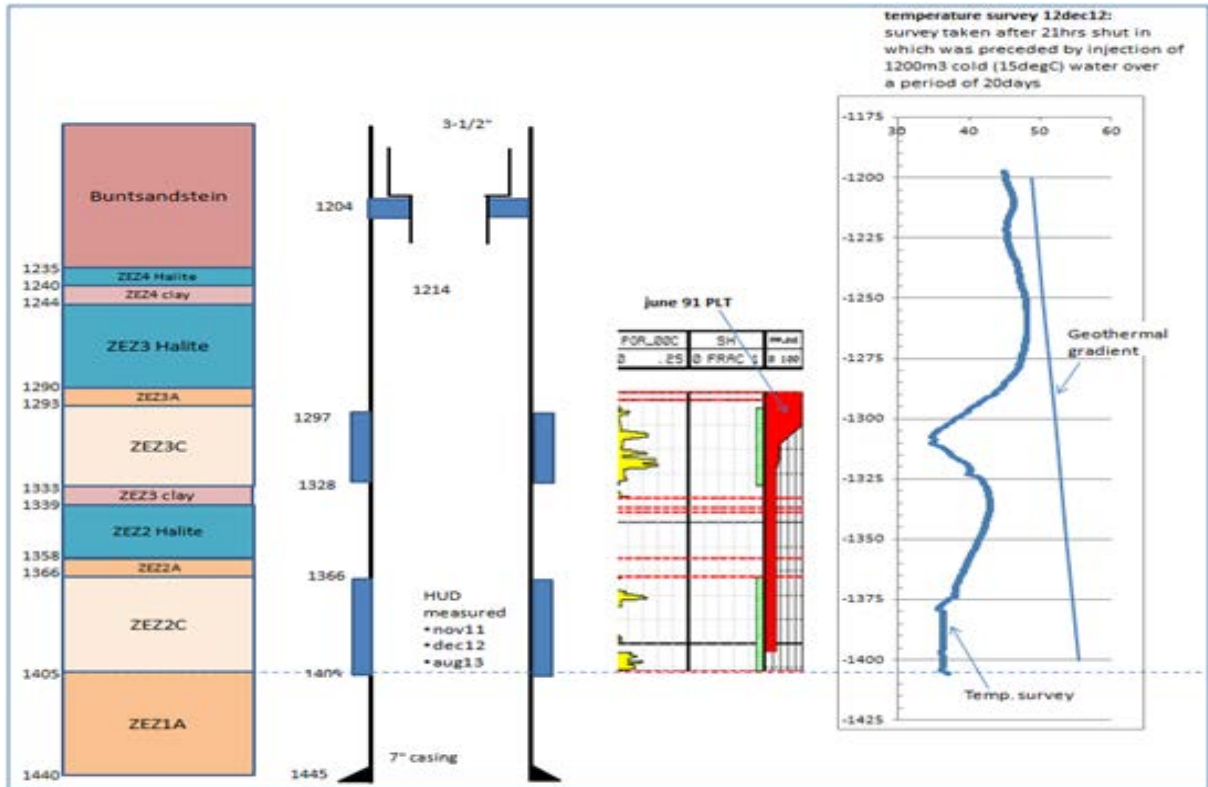

### 9.5.3 Well ROW7

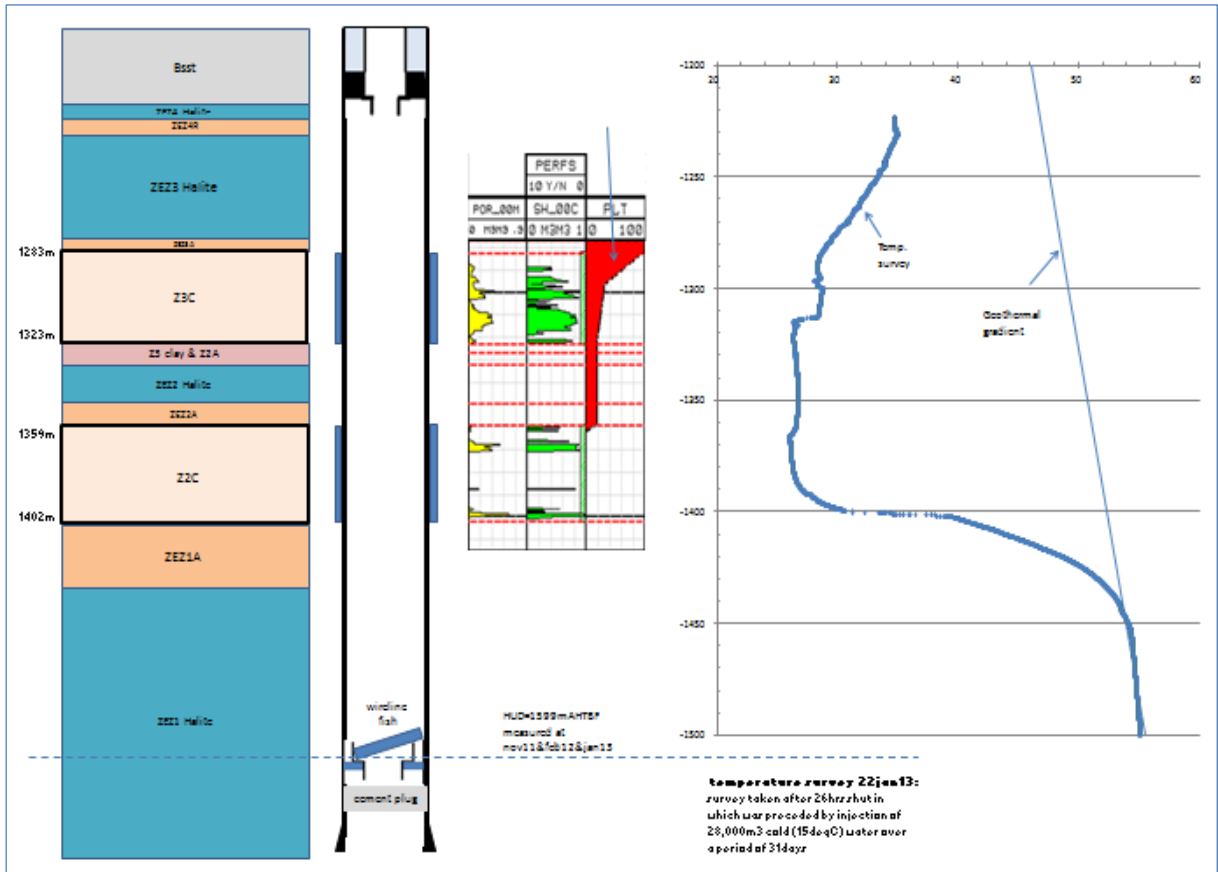

### 9.5.4 Well ROW9

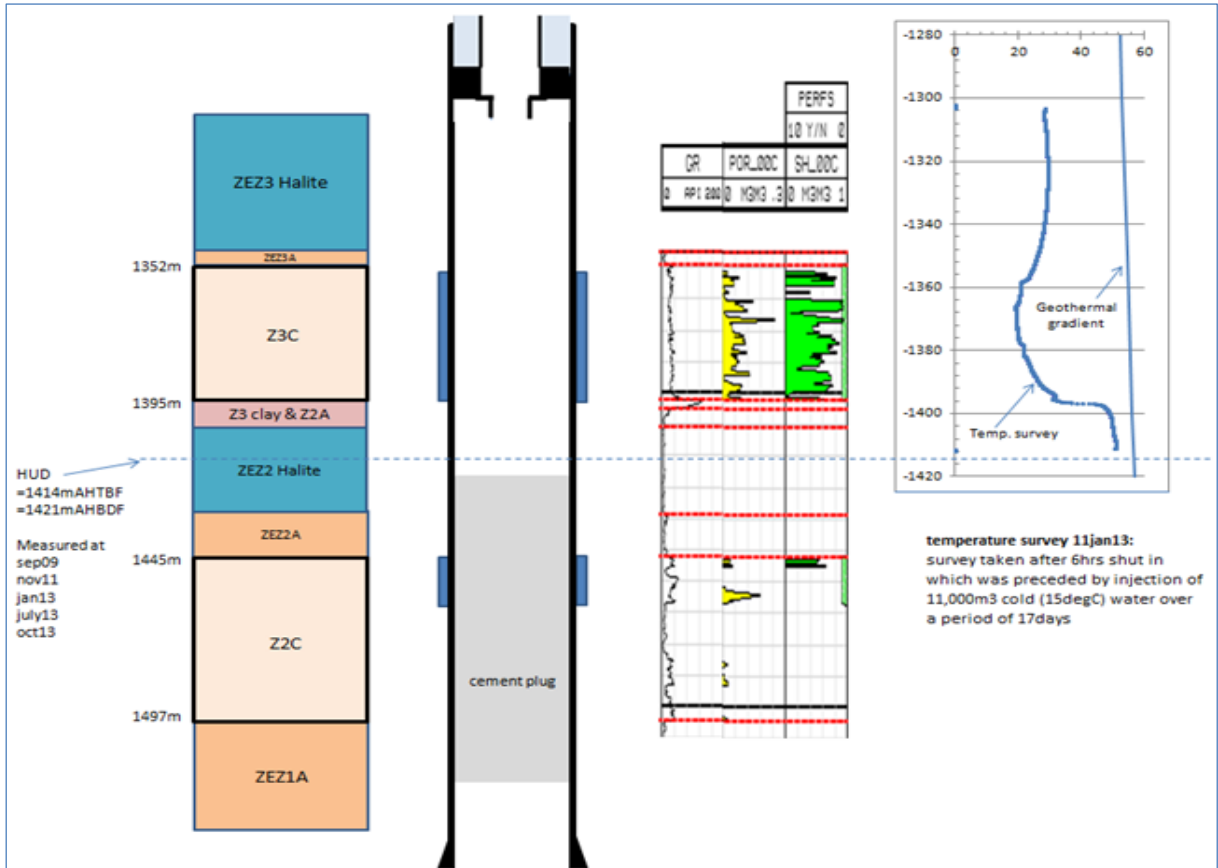

### 9.5.5 Well TUB7

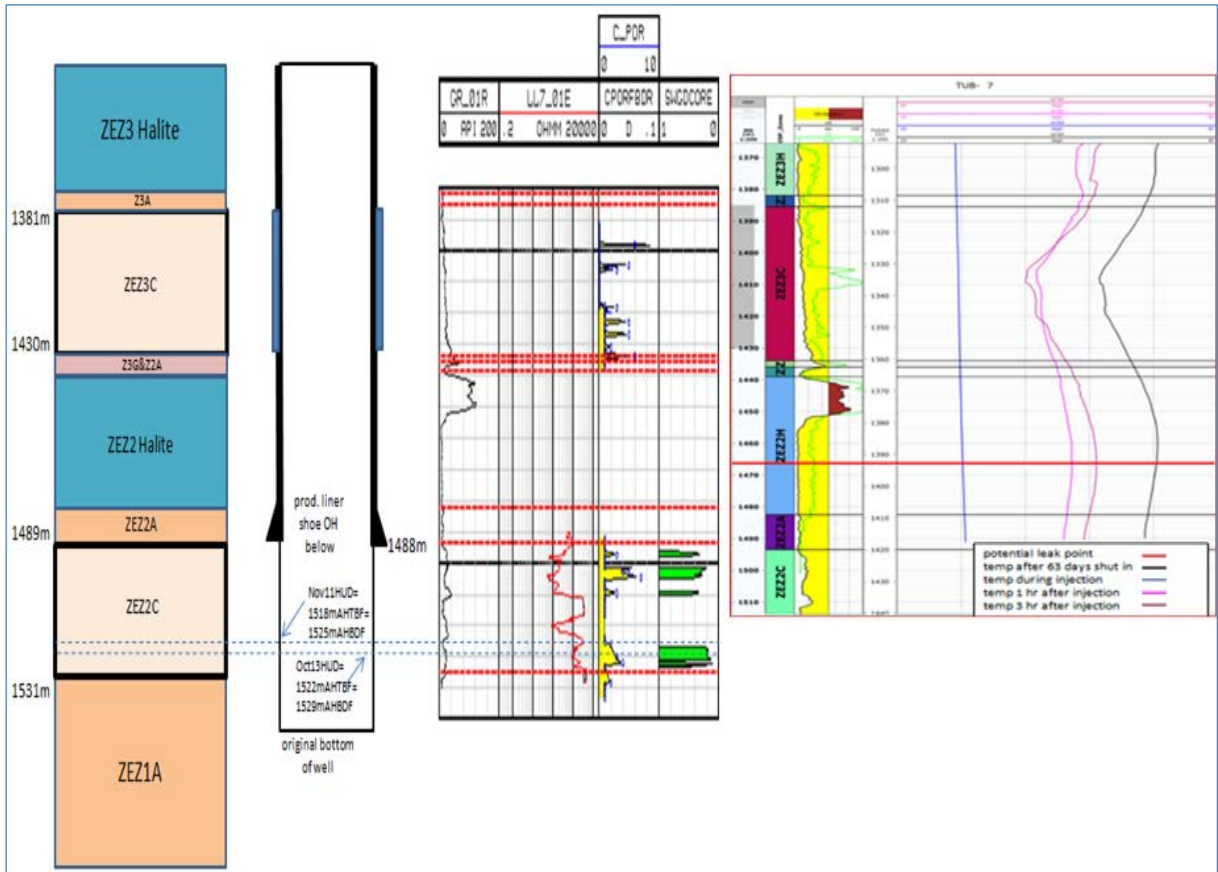

### 9.5.6 Well TUB10

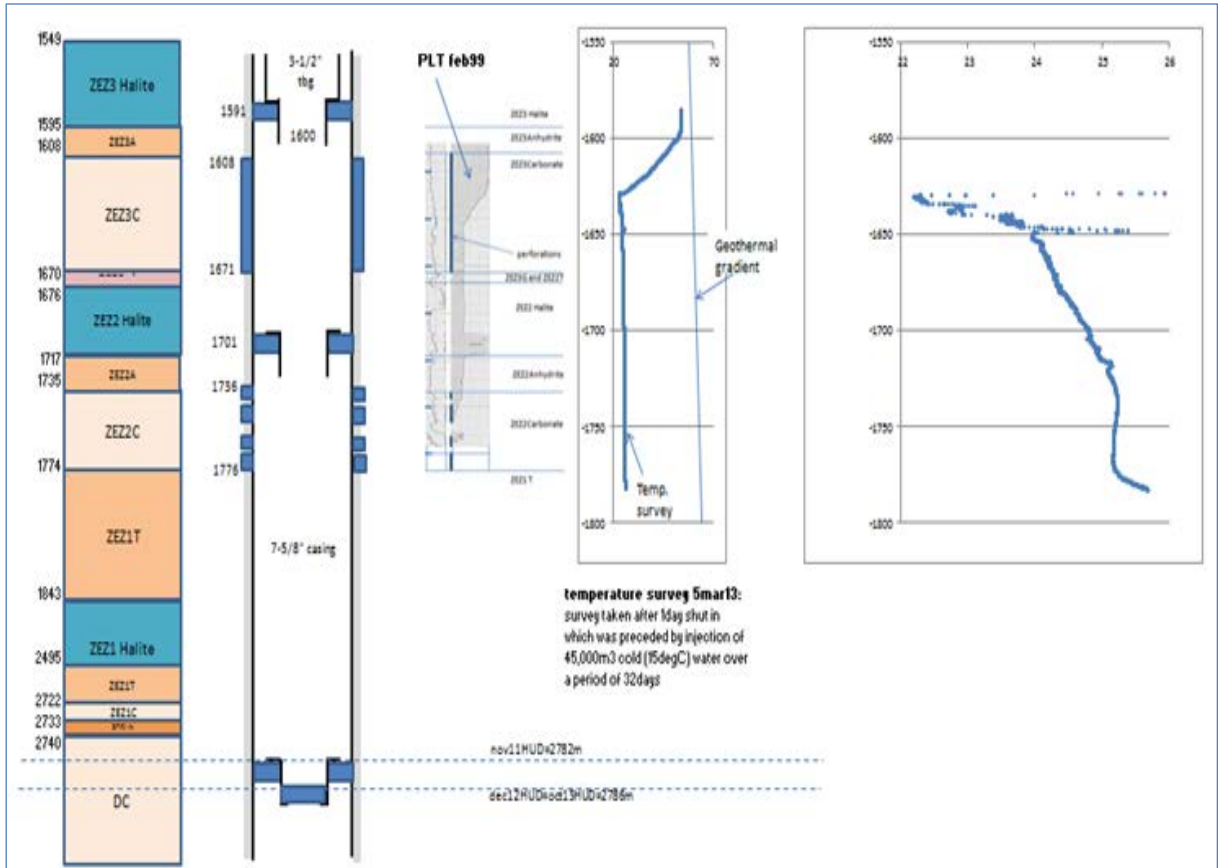



9.6.2 Well ROW9

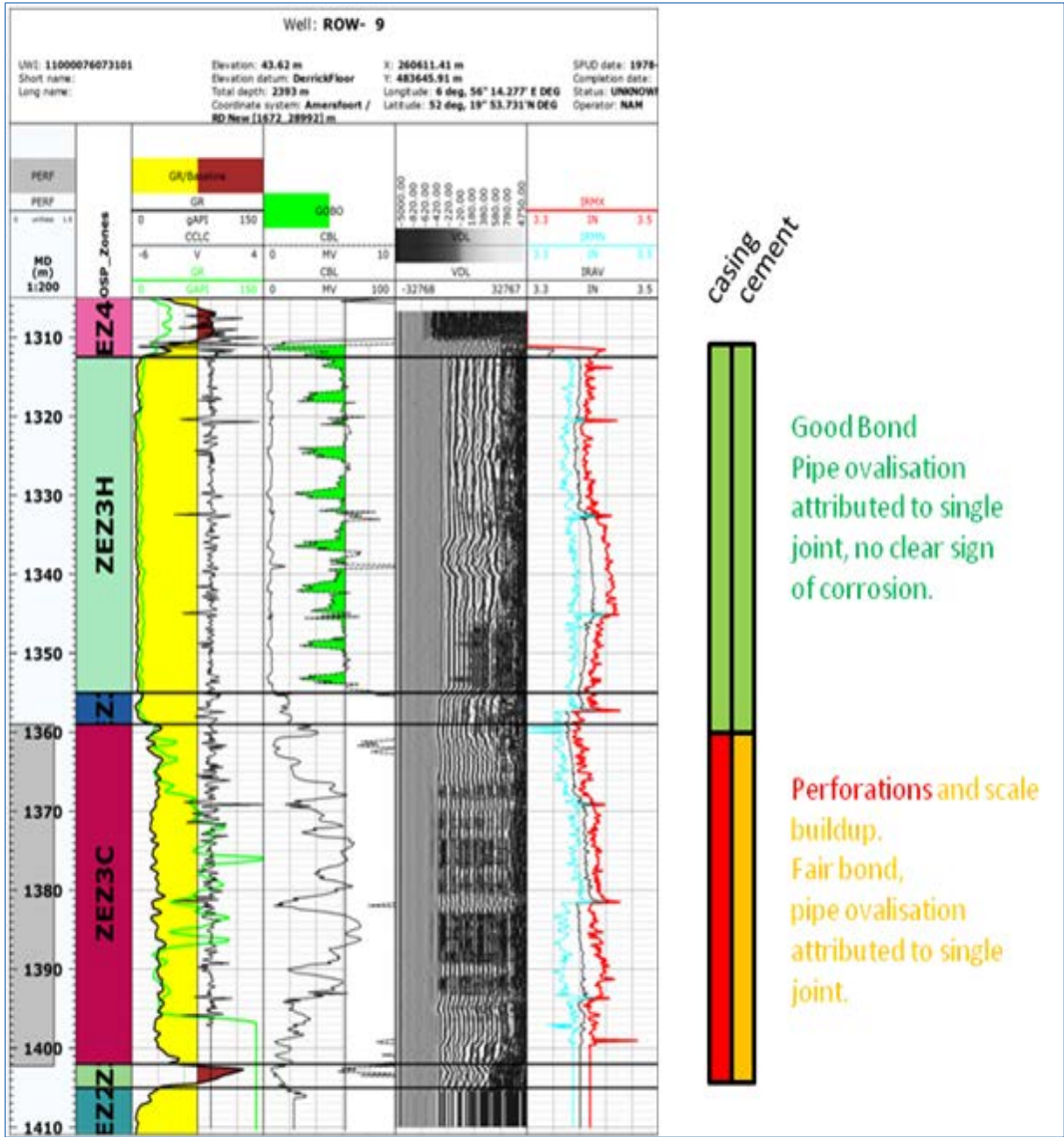



9.6.3 Well TUB7

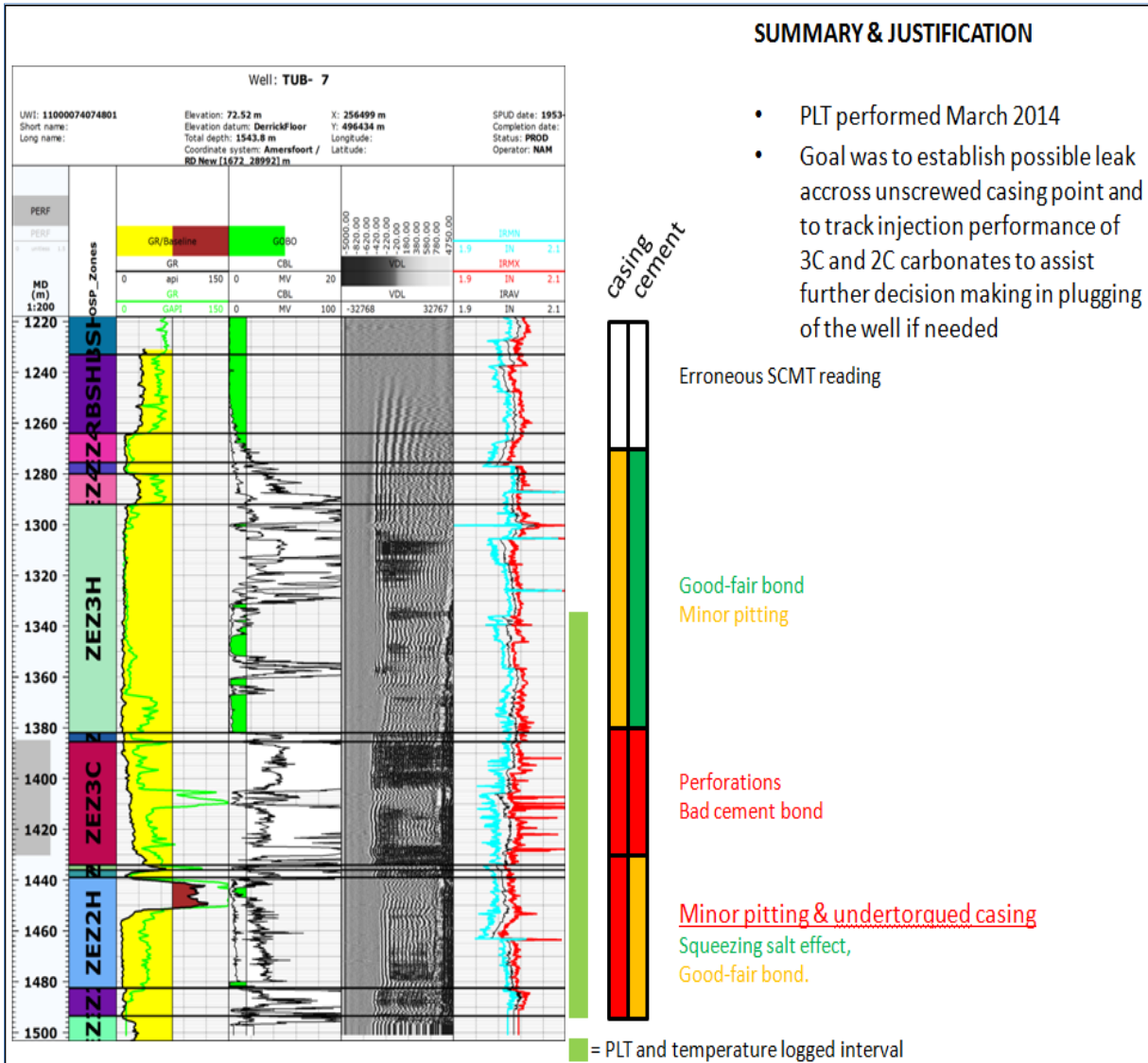



## 9.7 TUB7 well surveillance results

The casing calliper results in TUB7 show that the casing integrity might be compromised at several depths. Although there is no evidence that actual leakage may have occurred, the risk of exposing Halite at the ZeZe2H and ZeZ3H to injection water is perceived such that the well has been closed in until a full investigation into repair options is concluded.

[1] The PMIT-A calliper results indicate that at 1178 mAhtbf a larger diameter section in the casing. Detailed analysis of the calliper data renders this observation inconclusive. It is most likely a calibration error of the tool as it has just left the smaller ID tail-pipe. Independent of the above, there is good evidence that there is no communication between the wellbore and the B-annulus at this depth. On numerous occasions oil was sampled from the B-annulus (presumably coming from the Muschelkalk formation) suggesting that the entire B-annulus is fluid filled. This is also apparent from N<sub>2</sub> charging activities during the first 3 years of water injection. As the BHP is significantly sub-hydrostatic this means that a pressure connection between the wellbore and the B-annulus can be ruled out.

[2] At 1205 mAhtbf the PMIT-A indicates a chemical cut that was performed in 1974 to retrieve the top part of the 4½” casing. The PMIT-A calliper shows that this cut also penetrated the 7” casing whilst top of cement in the B-annulus is right at or just below the location of the chemical cut. However, as discussed above, there is no evidence suggesting that actual pressure communication exists between the wellbore and the B-annulus. This is corroborated by the fact that after the chemical cut the well was positively pressure tested against a RTTS packer, set at 1340 mAHdf, indicating that, at the time (1974), no connection existed between the wellbore and the B-annulus.

[3] At 1295 mAhtbf, the impact is visible of an unsuccessful chemical cut which preceded the cut discussed above. The PMIT-A calliper shows that the chemical cut did cut through the 4½” liner and the 7” casing (Figure 17). The cement bond behind the 7” casing was not verified as only a temperature log was run right after cementation. This temperature log does indicate a top of cement of 1210 mAHdf, but does not give any quality indication of the cement itself. However, fair-to good cement bonding is indicated across the ZeZ3H (Attachment 9.6.3), thus excluding a flow-past Halite scenario. It must be noted that the top of cement in the Attachment is measured at 1270 mAHbdf, because the CBL-tool only functions properly when immersed in fluid, which most likely coincides with that depth.

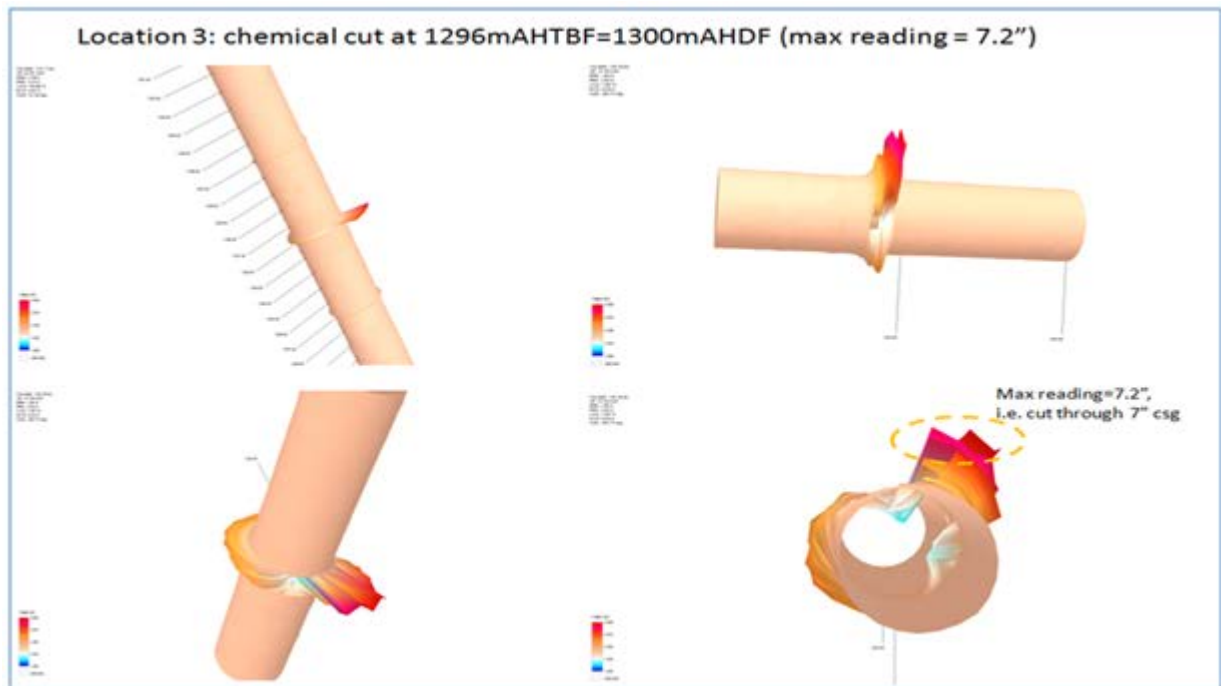
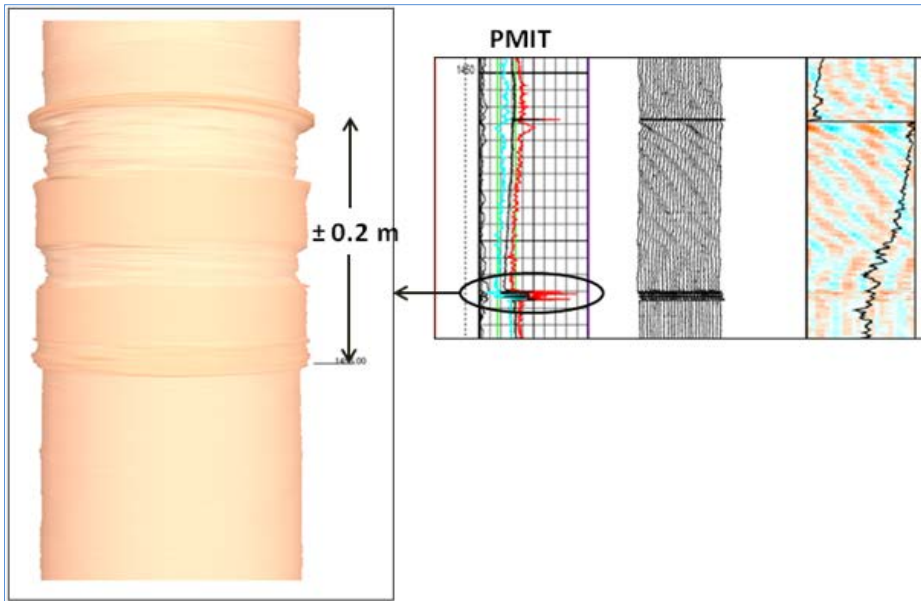

Figure 17 – PMIT-A calliper indicating cut through 4½”-liner and 7”-casing

[4] At 1335 mAhtbf marks are detected on the 4½” liner. These are likely formed during milling of a RTTS packer, which was set at this depth in 1974 before the chemical cuts at locations 2 and 3 were applied. This packer was used to pressure test the wellbore. However, given that the 7” casing is still expected to be intact a high integrity barrier exists between the ZeZ3H Halite formation and the wellbore.

[5] A calliper spike at 1450 mAhtbf is suspected to be a corrosion pit. This pit is found to penetrate 45% into the 4½” liner. This section will be subjected to regular casing callipers to monitor any further degradation of the liner at this location.

[6] The deepest potential integrity concern is at 1460 mAHtbf (1464 mAHdf), which is at the level of the ZeZ2H. The calliper and CBL signal observed are interpreted to represent a potentially undertorqued casing joint in a section with a poor cement bond. This carries the potential risk of directly exposing the ZeZ2H salt to injection water. Figure 18 shows the 3D-calliper image as derived from the PMIT-data.



**Figure 18 – 3D-calliper image of the undertorqued casing joint at 1464 mAHdf**

To further assess this risk a temperature survey and PLT was run past the exposed section (1464 mAHdf). The results of this additional logging are given in Figure 19 and Figure 20, respectively.

The temperature log does not provide any indications of a potential leak at the suspected casing joint. Moreover, because proper cement has been detected above and below the suspected joint as well as a good cement to formation bonding is indicated across the ZeZ2H, it is believed that a flow-past salt scenario does not exist (as explained in Chapter 4.3). The PLT shows at high injection rates (more than 2000 m<sup>3</sup>/d) a small difference in flowrate before and after the suspected joint. The measured difference is within the within tool accuracy. In addition there is a small difference in internal diameter above and below this depth. Both aspects render the possible evidence for leakage as inconclusive.

The repair of this suspicious casing joint is part of an integrated investigation of this well with the intent to repair and re-instate it as a water injector.

### Temperature survey results

A temperature survey was run before during and after injection to pick up a cooling signal arising from cold water injection.

- A cooling effect from regular injection ceased 63 days before logging is still visible over 3C perforations
- During injection, temperature gauge only sees cold water (blue line)
- 1 hr after injection well warming is noticed from geothermal heat influx.
- 3 hr after injection this effect becomes more apparent, differences at different parts of the well bore as well. The overall temperature log seems to approach 'normal' shut in conditions again.
- No sign of any water injection at potential leak point becomes apparent.

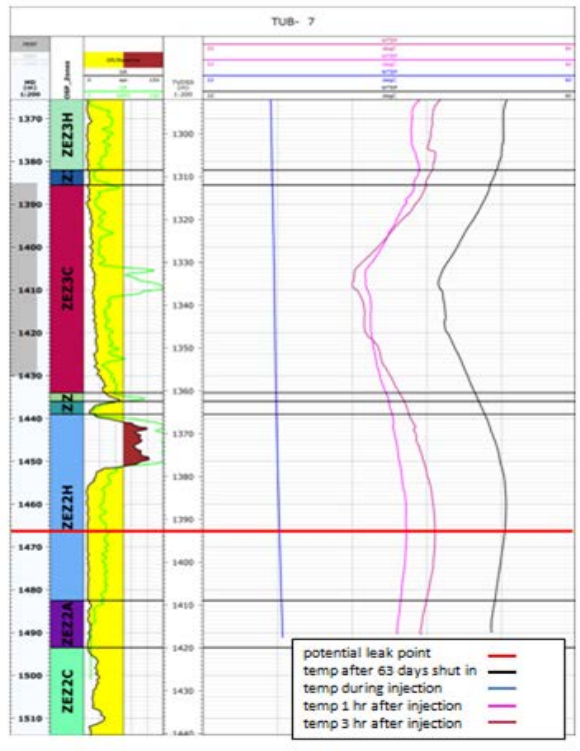

Figure 19 – Temperature logging results

### TUB-7 PLT main findings and results

Fullbore spinner and inline spinner were run together with temperature and pressure gauges to find a potential leak and to establish relative injection rates of 2C and 3C carbonates. The full bore PBMS spinner was damaged and released from the tool downhole. All data presented here are taken from the PILS Inline spinner.

- Lowest open hole completion across the 2C carbonate was out of reach of the tools;
- During shut in, no cross flow is observed between 2C and 3C.
- Only at the highest injection rate (2004 m<sup>3</sup>/d, a injection across the 3C perforations is visible.
- The 3C vs 2C injection capacity in this well is:
  - 15% at 2004 m<sup>3</sup>/d
  - no obvious injection in 3C at 758 m<sup>3</sup>/d
- Temperature logging over time does not indicate any water injection over potential leak point
- Spinner stations above and below leak point at 758 m<sup>3</sup>/d indicate a potential water loss over leak point, however within statistical ( $\sigma$ ) margin

Summarizing: at higher injection rates it is increasingly difficult to rule out injection at leak point.

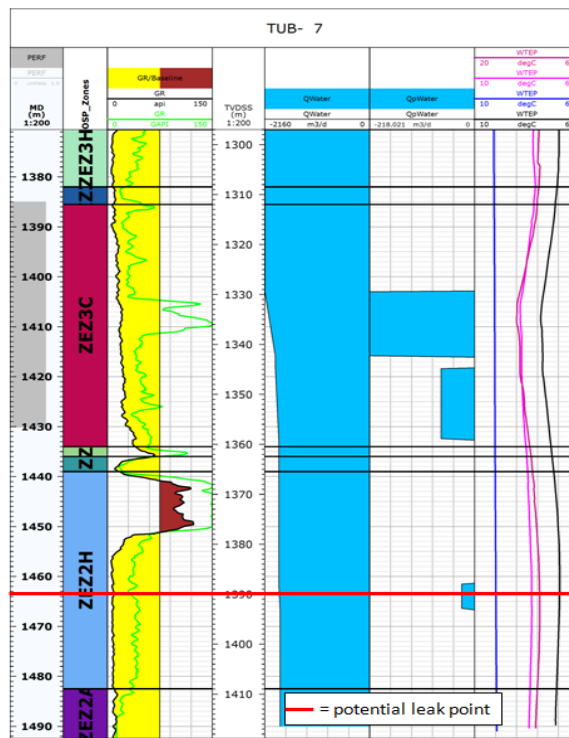

Figure 20 – PLT results